

The 376 is available as a **SINGLE PRESET** or a **DUAL PRESET COUNTER**. The Dual Preset Counter can be set as a Batch Counter. Both the Single Preset and the Dual Preset versions have an internal Totalizing Counter which will accumulate counts over numerous cycles. The 376 can be set up for Interval Counting Mode using a separate start signal, and can also be set up for count with Inhibit Mode.

HIGH SPEED COUNTING: The Single Preset 376 counts at a maximum frequency of 10 kHz. In addition to its high speed capabilities, a debounce circuit can be enabled to limit the count frequency to 100 Hz.

COUNTING MODES: The 376 is available as a Single Preset or a Dual Preset Counter. The Dual Preset Counter can be set as a Batch Counter. Both the Single Preset and the Dual Preset versions have an internal Totalizing Counter which will accumulate counts over numerous cycles. The 376 can be set up for Interval Counting Mode using a separate Start Signal, and can also be set up for Count with Inhibit Mode.

INPUTS/OUTPUTS: Two count inputs are available with the 376. These inputs can be set to count Uni- and Bi-directionally. They can also be set to accept Quadrature inputs and can multiply the quadrature signals X1, X2 and X4. Input 2 also operates as the Start input in Interval Mode and as the inhibit input in Count with Inhibit Mode.

These two inputs can be set to accept Current Sinking or Sourcing signals, and there is a High/Low Threshold (Bias) setting allowing the input of TTL level signals.

Two types of outputs are available. The Relay outputs are rated for 7 A at 250 VAC and 30 VDC. The NPN Transistor outputs are current sinking and are rated for 100 mA at 30 VDC. These outputs are field replaceable. Each output can be set to either Latch ON, Remain ON for a Time Delay, or turn OFF at a Preset.

SCALE FACTOR: A Prescale value can be set which allows the operator to view and set counts using real units of measure. The Prescale value is a multiplier which is applied to the count inputs to determine the display and preset values. The Prescale value can be set from 0.00001 to 9.99999. The 376 also allows setting of the decimal point position in any of 6 positions.

RESETTING THE COUNTER: The Counter can be reset using the Reset key on the panel or by using the external Reset Inputs. There are three current sinking external inputs. Each one is dedicated to resetting the Process, Batch and Totalizing Counters. In addition, the 376 can be set to either retain its count or reset upon power failure.

OPERATOR PANEL AND HOUSING: The 376 operator panel is dust and water tight and measures a compact 72mm². The panel features a high intensity blue vacuum fluorescent display. The display uses 8 digits for its English language operator prompts and 6 digits to display the count value. For operator use, there are 4 snap action keys which allow the operator to easily view Process Count, Batch Count, Totalizer Count, Presets, Scale Factor, Output Settings and Decimal Point position. The 376 can be set to lock out various displays from the operator. One key is dedicated to Resetting the Counter. This key can also be locked out.

SET-UP: Set-up of the 376 is accomplished using 16 DIP switches which are located inside the unit. These DIP switches give a visual indication of how the Counter is set-up, and eliminate the use of complex programming codes. Field replacement of the unit is quick. To replace a unit, remove the old unit from its housing, set the DIP switches in the new unit to the same positions, and plug the new unit in. It's that simple.

AUXILIARY POWER SUPPLY: To power sensor and encoder inputs, a regulated 12 VDC auxiliary power supply is provided. This supply can provide 120 mA of current, and is short circuit



Digital Counter

- 6 Digit Count Display
- Single Preset, Dual Preset, Batch Counting Modes
- Interval Counting Mode with Separate Start
- Count with Inhibit Mode
- Internal Totalizing Counter
- Prescaler 0.00001 to 9.99999
- 6 Decimal Point Positions
- High Intensity Blue V-F Display
- Easy English Language Operator Prompts
- 72mm² Panel - Dust, Water Tight
- 4 Snap-Action Keys
- Plug-in Housing (Quick Replacement)
- Sinking, Sourcing, TTL Inputs
- Single, Bidirectional, and Quadrature (X1, X2, X4) Counting
- Relay or Transistor Outputs
- Outputs Latched, Timed, or Off at Presets
- Regulated 12 VDC Aux. Power Supply

OPERATION

The Series 376 Preset Counter is a predetermining counter that will count high speed unidirectional, bi-directional, or quadrature input signals, and will activate an output when the predetermined preset value is reached. The unit is available in both Single and Dual Preset models, and includes an internal totalizer. Also, the 376 counter will operate as a Batch Counter using the second preset as a Batch Preset. The Series 376 comes with a variety of counting modes. The operation of each counting mode is described below.

COUNT UP FROM ZERO TO A GIVEN PRESET: The Output in the Counter is activated when the Count equals the Preset. In the Dual Preset Model, the Counter counts up from zero and Output 1 is activated when Preset 1 is reached and Output 2 is activated when Preset 2 is reached.

COUNT DOWN FROM A PRESET TO ZERO: When Reset is pressed, the Counter is set to the Preset Value. When the Count Value equals zero, the Output is activated. In the Dual Preset Model, the Counter counts down from the High Preset value and activates one Output when it reaches the Low Preset Value; the other Output is activated when the Counter counts down from the Low Preset Value and reaches zero.

INTERVAL MODE: In this mode, the Counter will not begin counting until Input 2 is turned ON, indicating a Start Signal. Once the Start Signal is received, the Output will turn ON and the Counter will count. The Output will then turn OFF at the preset or zero. The Start Signal must be activated each time the process is reset, even when the Counter is set to Auto Reset

BATCH MODE - DUAL PRESET MODELS ONLY: In the Batch Mode, Input 1 is the Count input and will turn ON at Preset 1. Each time Output 1 turns ON, the Batch Counter will record a count. When the Batch Counter value equals the value in Preset 2, Output 2 will turn ON. The Batch Mode must be Manually Reset (unless T2 is set to 00.00 (.5 w/ AR) for Auto Reset).

TIMED OUTPUTS: The Outputs can be delayed before turning OFF by setting time delay values for each output. Once the Preset is reached, a time delay, according to the time value set, will occur before the outputs turn OFF. This value can range from 0.00 SEC (OFF at Preset) to 99.99 SEC (Latched ON). In addition, the outputs can also be set to turn OFF upon reaching the preset for the other output in the Dual Preset Model.

SCALE FACTOR: A Prescale value can be set to allow viewing and setting counts using real units of measure. The Prescale value is a multiplier which is applied to the count in-put(s) to determine the count display and preset values. The Prescale value can be set from 0.00001 to 9.99999. In addition, the decimal point can be set on the display to any one of 6 positions.

DIMENSIONS (INCHES/MILLIMETERS)

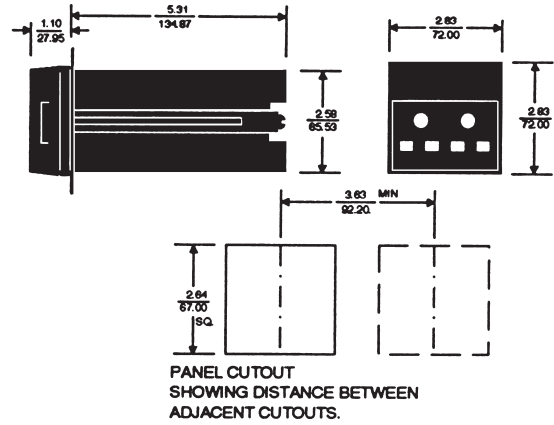

WIRING

376 TERMINAL WIRING

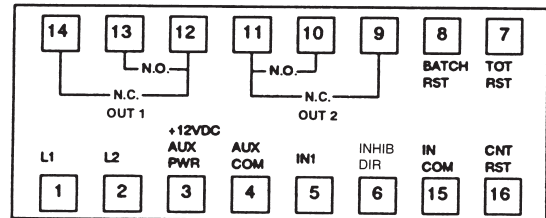

OUTPUT WIRING

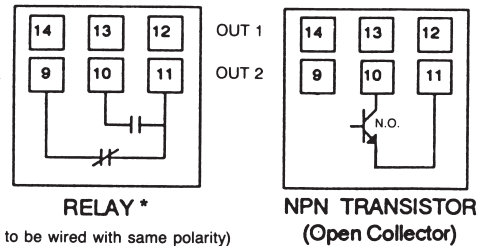

* (Contacts to be wired with same polarity)

COUNT INPUT WIRING - SINK INPUT SIGNAL

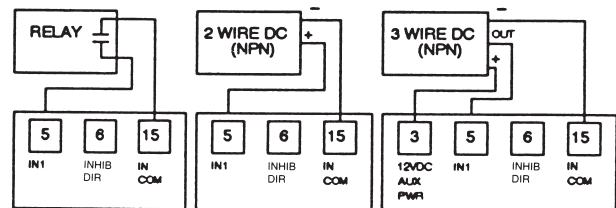

COUNT INPUT WIRING - SOURCE INPUT SIGNAL

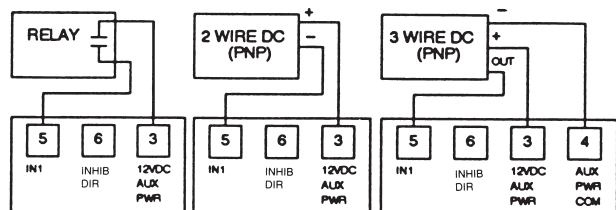

SPECIFICATIONS

MODELS	Single and Dual Preset with either NPN (Solid State) or Relay Outputs.	
COUNT INPUT MODES (SWITCH SELECTABLE)	Bi-Directional Quadrature X1 Quadrature X2 Quadrature X4 Count with Inhibit Interval with Start Input	
SETTINGS (FRONT OF PANELS)	Presets	1 to 999,999
	Scale Factor	0.00001 to 9.99999
	Timed Outputs	00.01 to 99.98 SEC Latched Off at Preset
	Decimal Position	0 to 6
OPERATING FEATURES (SWITCH SELECTABLE)	Count Up or Count Down Count/Go or Count/Stop Sink or Source Count Input High or Low Threshold (Bias) Auto Reset at High preset (Count Up) Zero (Count Down) After Timed Output Totalizer Dual Preset/Batch mode Security lockout Access to Presets Access to T1, T2, SF, DP Front panel Reset Reset on Power Up	
COUNT INPUTS	Sink - 9.4K ohm pull up Max. current = 1.25 mA	
	Source - 4.7K ohm pull down Max. voltage = 30 VDC, @ 7 mA	
	High Bias ViL = 5.5 V Max. ViH = 7.5 V Min.	
	Low Bias ViL = 1.5 V Max. ViH = 3.75 V Min.	
	Debounce - reduces count Input 1 to 100 Hz (Input 2 no debounce.) Interval start requires 15 mSEC minimum pulse. (Can be momentary or sustained.)	

MAXIMUM COUNTING FREQUENCY	10 kHz Count Up Mode 9 kHz Count Down Mode Reduce by 3 kHz when Totalizing Counter is enabled Reduce by 2 kHz when Auto Reset is enabled Min. pulse 10 µSEC on; 90 µSEC off.
REMOTE RESETS	Count, Batch, Totalizer Min. 15 mSEC pulse Pulled to 5V via 8K ohm res. Active Low. ViL = 0.5V Max. Max. current = .625 mA.
OUTPUT - RELAY	Life 100 million operations (no load) Contact Rating 7 amp @ 30 VDC or 250 VAC, 1/4 HP
DC SUPPLY	12 VDC Regulated, ±4% Max. current = 120 mA
MEMORY	Non Volatile EEPROM 230,000 Power Losses MIN 10 Year Retention
DISPLAY	8 Digit, 14 Segment 5 mm x 4.1 mm Blue Vacuum Fluorescent
OPERATING TEMPERATURE	0° F to 140° F
HUMIDITY	0% to 80% RH Non-condensing
POWER REQUIREMENTS	120 VAC 95 - 132 VAC 240 VAC 190 - 264 VAC 50 / 60 Hz Max. Power = 8 VA
TERMINALS	16 screw terminals located accessible from rear
HOUSING	Plug in, 72mm ² DIN Fully Gasketed, Dust and Watertight.
WEIGHT	1.47 lbs. SHIP 2.0 lbs.

MODEL NUMBER

MODEL NUMBER	376B			50		
PRESETS	Single Preset	100				
	Dual Preset (with batch)	200				
VOLTAGE & FREQUENCY	120, 50/60 Hz		Q			
	240, 50/60 Hz		R			
FUNCTION	Counter with Sealing			50		
OUTPUT TYPE	Relay				R	
FEATURES	Standard unit					X
	Special					K

ACCESSORIES

Surface mounting bracket kit	353-260-27-00:
Round Cutout Retrofit kit	305-265-61-70:
Square Cutout Retrofit kit	376-320-01-00:

For prices and further information, consult factory.

SETTING THE COUNTER

To set the Counter, there are four push-button keys located on the front of the unit. These buttons are provided to allow the user to select, change and save various values. These key operations are dependent on the DIP Switch settings of the unit (see below).

In addition to the normal counting modes of the unit, the 376B has the capability of operating as a Batch Counter and a Totalizer Counter. When these modes are activated, the functions of the Counter change accordingly. Pressing the RESET key, with the Count, Batch, or Totalizer value displayed, will reset that value.

This figure shows the front of panel with the Process Count value displayed. Pressing SELECT will scroll through a menu of options.



After one of these options is displayed for a second, the value for this option is automatically displayed. Once the option value is displayed, pressing the < key will move one digit to the left and the ^ key will increment the value by one. Then the SELECT key must be pressed to save the new value. Pressing RESET will return to the Process Count display. If SELECT is not pressed after a change, RESET will return to the count display and the change will not be entered.

After one of these options is displayed for a second, the value for this option is automatically displayed. Once the option value is displayed, pressing the < key will move one digit to the left and the ^ key will increment the value by one. Then the SELECT key must be pressed to save the new value. Pressing RESET will return to the Process Count display. If SELECT is not pressed after a change, RESET will return to the count display and the change will not be entered.

Selections in addition to Process Count are:

Totalizer - counts accumulated since last Totalizer Reset. When the total counts exceed 99,999,999 the Totalizer will blink. Pressing RESET will scroll through the actual value, pressing RESET a final time will reset the value to zero.



Batch - number of cycles elapsed in Batch Mode.



Preset 1/Preset 2 - value compared with the actual count. When the Preset Value is displayed, the Preset LED on the panel will light, indicating which preset is displayed.



Prescale - this factor will scale the input counts. The count signal is multiplied by the prescale value to determine the count display. The prescale value can range from 0.00001 to 9.99999.



NOTE: If the prescale value is greater than 1, the output will energize when the count value passes the preset value. Output 1/ Output 2 - time delay setting for outputs.

Decimal - the number of decimal positions for the display.



When the Counter reaches its Presets, the Outputs will activate and the LEDs on the panel will flash, indicating which output is activated.



DIP SWITCH SETUP-To set up the Counter for operation, a series of DIP switches located inside the unit must be set.

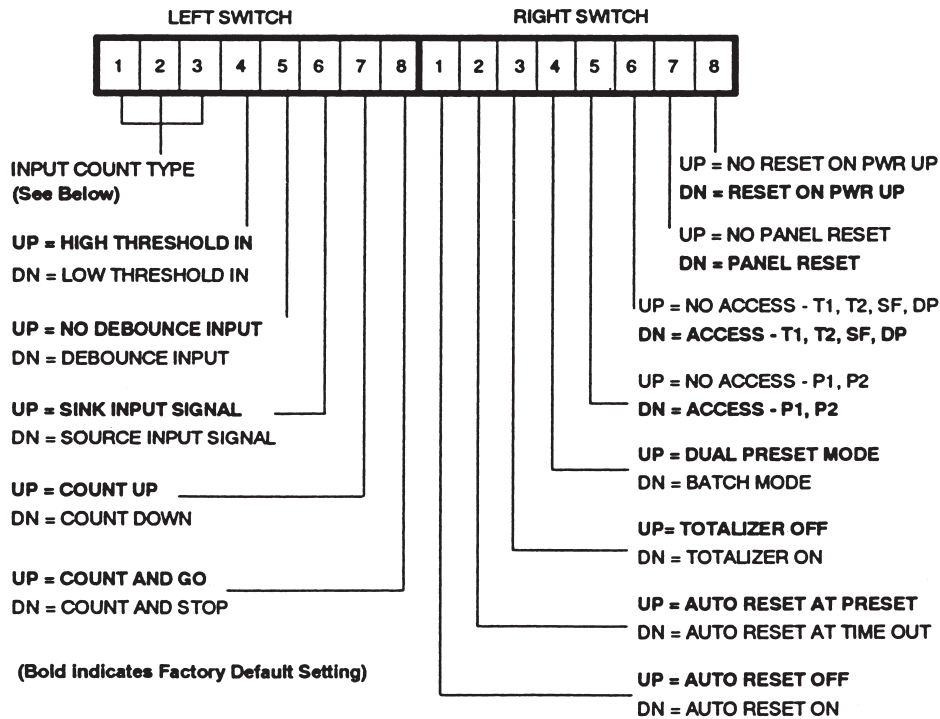

INPUT COUNT TYPE

- BI-DIRECTIONAL COUNTER
- QUADRATURE COUNTER
- QUADRATURE COUNT X2
- QUADRATURE COUNT X4
- COUNT WITH INHIBIT
- INTERVAL MODE (COUNTER WITH START SWITCH INPUT)

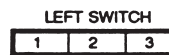

- | | | |
|----|----|----|
| UP | UP | UP |
| DN | UP | UP |
| UP | DN | UP |
| DN | DN | UP |
| UP | UP | DN |
| DN | UP | DN |