

Components

TCP stocks a variety of component parts for replacement. These components consist of connectors, panels, clamps, tube adapters, sealants, terminal heads & head covers.





WATER PROOF CONNECTOR

Series 106

- Accommodates Thermocouple Sheath Diameters from .062" to .250"
- Connector Bodies are Type 303/304 Stainless Steel
- Polarized Connector Contains Matched Thermocouple Alloy Contacts to Insure Accuracy
- Assembly is Rated 225°F (107°C) Service
- Unit is Pre-Wired at Factory with Extension Grade PVC Lead Wire

An ideal assembly for applications where extreme moisture and corrosive conditions exist. This quick-disconnect thermocouple connector is complete with a factory-assembled flex-hose extension lead and thermocouple. Interlock construction of vinyl-covered stainless steel flexhose, is supplied with a 1/4" or 1/2" NPT male stainless purpose conduit box. 48" flexhose extension standard. Other lengths available on request.

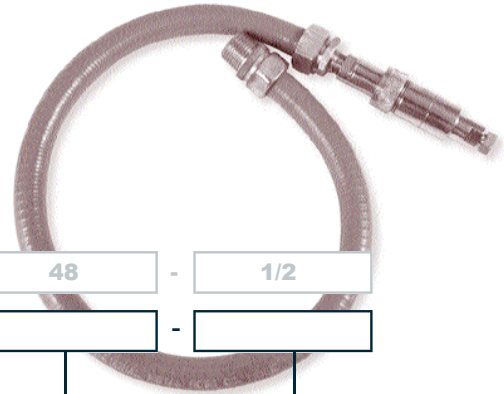

Enter a selection for each item, please fax your inquiry to TCP.

Example: 106 - - - -

106 - - - -

CODE	WIRE CALIBRATION
J	Iron/Constantan
K	Chromel/Alumel
T	Copper/ Constantan
E	Chromel/Constantan
K is standard	

CODE	SHEATH DIAMETER
C	.062"
D	.125"
E	.187"
F	.250"

LEAD LENGTH "X"
Specify in whole inches 01 to 99

CODE	PIPE SIZE
1/4	1/4" NPT
1/2	1/2" NPT
1/2" is standard	

WATER PROOF CONNECTOR

Series 107

- Accommodates any Two Combination of Sheath Diameter from .062" to .250"
- Connector Bodies are Type 303/304 Stainless Steel
- Polarized Connector Contains Matched Thermocouple Alloy Contacts to Insure Accuracy
- Assembly is Rated 225°F (107°C) Service

A waterproof quick-disconnect connector, designed for mineral oxide insulated, metallic-sheathed thermocouples and extension leads. This assembly is identical to the 106 Series illustrated above, except that it has a compression-type fitting instead of the flexible hose-protected lead and end fitting instead of the flexible hose-protected lead and end fitting. This connector allows you to connect metallic-sheathed thermocouples or leads of the same or varying diameters by selecting compression fitting sizes.

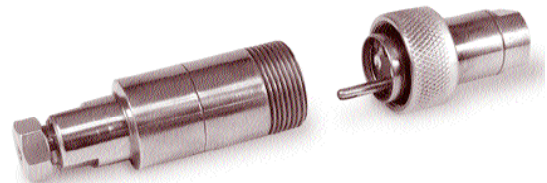

Enter a selection for each item, please fax your inquiry to TCP.

Example: 107 - - -

107 - - -

CODE	WIRE CALIBRATION
J	Iron/Constantan
K	Chromel/Alumel
T	Copper/ Constantan
E	Chromel/Constantan
K is standard	

CODE	SHEATH DIAMETER Thermocouple Side
C	.062"
D	.125"
E	.187"
F	.250"

CODE	SHEATH DIAMETER Lead Side
C	.062"
D	.125"
E	.187"
F	.250"

HIGH TEMPERATURE CONNECTOR

108/109 Series

- A specialized thermocouple connector for high temperature applications up to 1000°F (538°C)
- All fastenings are stainless steel and are non-magnetic and non-rusting.

A specialized thermocouple connector for high temperature applications up to 1000°F (538°C). This positive contact polarized connector is color glazed overall to conform to ANSI recommended colors for specific thermocouple calibrations. Overall color is permanent and will not fade after exposure to 1000°F (538°C)

The contact supplied in this connector are machined from matched thermocouple alloys in all calibrations, except those used with Platinum vs Platinum Rhodium thermocouples. Platinum vs Platinum Rhodium connectors are furnished with Copper vs #11 Alloy contacts. All fastenings are stainless steel and are non-magnetic and non-rusting.

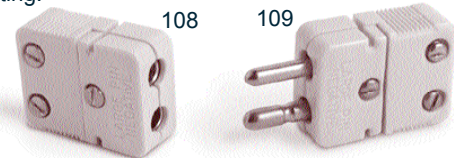

Enter a selection for each item, please fax your inquiry to TCP.

Example:

-
 -

CODE	CONNECTIONS
108	Jack
109	Plug

CODE	CONNECTIONS	COLOR
E	Chromel/Constantan	Purple
J	Iron/Constantan	Black
K	Chromel/Alumel	Yellow
RS	Copper/Copper #11	Green
T	Copper/Constantan	Blue
U	Copper/Copper	White

STANDARD CONNECTOR

110/111 Series

- A standard industrial ANSI color coded thermocouple connector for use up to 350°F (177°C).
- The housing is made of glass filled nylon instead of ceramic and has much improved impact resistance.

A standard industrial ANSI color coded thermocouple connector for use up to 350°F (177°C) continuous. The housing used in the Series 110 and Series 111 is a type of glass filled nylon instead of ceramic and has much improved impact resistance. Contacts are rolled thermocouple alloy material except for Platinum vs. Platinum Rhodium connector which have copper vs. copper #11 alloy contacts. Split cap design permits easy electrical hook-up, without removing the pins.

This connector, like the high temperature model is interchangeable with standard industrial systems and in particular lend themselves to connector panel application.

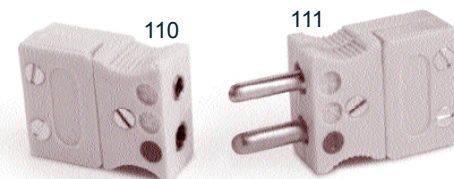

Enter a selection for each item, please fax your inquiry to TCP.

Example:

-
 -

CODE	CONNECTIONS
110	Jack
111	Plug

CODE	CONNECTIONS	COLOR
E	Chromel/Constantan	Purple
J	Iron/Constantan	Black
K	Chromel/Alumel	Yellow
RS	Copper/Copper #11	Green
T	Copper/Constantan	Blue
U	Copper/Copper	White

MINIATURE CONNECTOR

130/131 Series

- This miniature connector is ideal for use where space is at a premium.
- The body is glass filled nylon with an overall temperature rating of 350°F (177°C) continuous.

A miniature connector is ideal for use where space is a premium. The body is glass filled nylon with an overall temperature rating of 350°F (177°C) continuous.

This connector is widely used on probes for quick connection to portable instrumentation. The advanced design permits quick wiring with even fine gauge wire. Consult factory for high temperature requirements.



Enter a selection for each item, please fax your inquiry to TC

Example:

-

-

CODE	CONNECTIONS
130	Jack
131	Plug

CODE	CONNECTIONS	COLOR
E	Chromel/Constantan	Purple
J	Iron/Constantan	Black
K	Chromel/Alumel	Yellow
RS	Copper/Copper #11	Green
T	Copper/Constantan	Blue
U	Copper/Copper	White

3 PIN CONNECTOR

150/151 Series

- A three pin version of the 110 and 111 series connector for use on thermocouple or RTD assemblies.
- This connector has 3 rolled copper pins with polarity markings, a glass filled nylon shell rated to 350°F (177°C) continuous.

3 pin version of the 110 and 111 series connector for use on thermocouple or RTD assemblies. This connector has 3 rolled copper pins with polarity markings, a glass filled nylon shell rated to 350°F (175°C) continuous use and utilizes the same connecting hardware as the 110/111 series. Interchanges with other similar industry standard connectors. Use 150-U Plug or 151-U Jack for RTD applications.

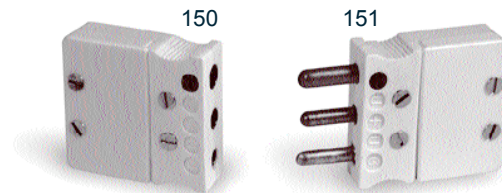

Enter a selection for each item, please fax your inquiry to TCP.

Example:

-

-

CODE	CONNECTIONS
150	Jack
151	Plug

CODE	CONNECTIONS	COLOR
E	Chromel/Constantan	Purple
J	Iron/Constantan	Black
K	Chromel/Alumel	Yellow
RS	Copper/Copper #11	Green
T	Copper/Constantan	Blue
U	Copper/Copper	White

JACK PANEL

1013 Series

- A five point jack that can be readily installed into a standard FS or FD conduit box.
- Contact materials are thermocouple alloys embedded in molded phenolic.
- Each circuit is identified by numbers 1-5. Jack panel accepts series 109 and 111 plug.

A five point jack that can be readily installed into a standard FS or FD conduit box. Contact materials are thermocouple alloys embedded in molded phenolic. Each circuit is identified by numbers 1 through 5. Jack panel accepts Series 109 and 111 plugs.



Enter a selection for each item, please fax your inquiry to TCP.

Example: 1013 -

1013 -

CODE	CONNECTIONS	COLOR
J	Iron/Constantan	Black
K	Chromel/Alumel	Yellow
RS	Copper/Copper #11	Green
T	Copper/Constantan	Blue

MULTI-STRIP PANEL

1041 Series

- Panels available in 2, 4, 6, 8, 10, and 12 circuits, also in combinations of thermocouple alloys in one strip.
- Combinations must be multiples of two and must total the number of circuits in each strip.
- The overall temperature rating is 400 degrees F continuous.

Panels available in 2,4, 6,8, 10 and 12 circuits; also in combination of thermocouple alloys in one strip. Combinations must be multiples of two and must total the number of circuits in each strip. Please specify number of points and calibration desired. All circuits are numerically identified. Furnished complete with necessary hardware for mounting into panels. The overall temperature rating is 400°F continuous.



Enter a selection for each item, please fax your inquiry to TCP.

Example: 1014 - -

1014 - -

CODE	CONNECTIONS	COLOR	CODE	NUMBER OF CONNECTIONS	PANEL CUT OUT	
					Length	Height
E	Chromel/Constantan	Purple	2	2	1-5/16"	1-1/4"
J	Iron/Constantan	Black	4	4	2-13/16"	
K	Chromel/Alumel	Yellow	6	6	4-5/16"	
RS	Copper/Copper #11	Green	8	8	5-13/16"	
T	Copper/Constantan	Blue	10	10	7-5/16"	
U	Copper/Copper	White	12	12	8-13/16"	



CABLE CLAMPS

1209 Series

- Recommended for use with series 108, 109, 110, 111, 150 and 151 connectors. This clamp will accommodate extension leads up to 3/8" diameter.



Example: 1209

1239 Series

- Recommended for use with series 130 and 131 connectors.
- This clamp will accommodate extension leads up to 3/8" diameter.



Example: 1239

TUBE ADAPTERS

1210 series

- For use with 108, 109, 110, 111, 150 and 151 connectors to rigidly mount a quick disconnect to your sheathed thermocouple.



Enter a selection for each item, please fax your inquiry to TCP.

Example: 1210 -

1210 -

CODE	SHEATH DIAMETER
C	.062"
D	.125"
E	.187"
F	.250"

1240 series

- For use with 130 and 131 connectors to rigidly mount a quick disconnect to your sheathed thermocouple.



Enter a selection for each item, please fax your inquiry to TCP.

Example: 1240

1240 -

CODE	SHEATH DIAMETER
C	.062"
D	.125"

WEATHERPROOF BOOT

1471 SERIES

- A flexible neoprene rubber boot especially designed for moisture proofing wire connections on the 1015 or the 1016 series head.
- The boot fits tightly around the base of the head, and 1/8" to 3/16" tapered hole seals a variety of leadwire diameters. In pairs, the boot also can be used to moisture-proof combinations. Supplied in pairs

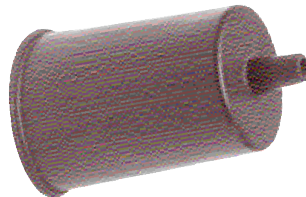

Example: 1471

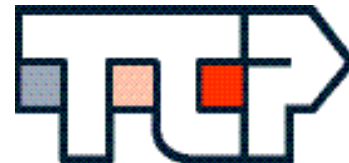

THERMOSEAL

- Polymerized Low-Viscosity Silicone
- Prevents Moisture penetration up to 1000°F (538°C)
- 2 oz. bottles standard, 8 oz. available.

"Thermoseal" is a polymerized low-viscosity silicone fluid with proven ability to form a positive moisture barrier for mineral insulated thermo-couple and heater elements.

"Thermoseal" is absorbed into the pores of the mineral oxide insulating material, where after heat polymerization, it remains to prevent the penetration of moisture up to approximately 1000°F (538°C).

"Thermoseal" will not carbonize, therefore there is no loss of insulation value, should the seal area be exposed to greater than 1000°F (538°C). Numerous and extensive laboratory tests have proven the reliability of "Thermoseal"

"Thermoseal" is supplied in standard 2 oz. bottles, 8 oz. bottles available.

Enter a selection for each item, please fax your inquiry to TCP.

Example: Thermoseal -

Thermoseal -

CODE	BOTTLE SIZE
2	2 oz.
8	8 oz.



LEADWIRE ADAPTER

- Open end thermocouples should be sealed with a moisture sealant such as "Thermoseal" after conductors have been exposed prior to attaching leadwire.

A small, easily assembled transition fitting for adapting sheathed, mineral oxide insulated thermocouples to leadwires. the leadwire adapter completely encapsulates the transition splice forming an insulating shield and providing an effective strain relief.

The adapter provides for secure mounting on the sheathed thermocouple and a spring allows the leadwire to flex in a large radius bend thus eliminating wire breakage. Due to the fact the transition is enclosed within the adapter it is both moisture proof and vibration and shock resistant.

Assembly is quite simple and may be performed in the field as easily as in the shop. No special tools are required, aside from the basic materials - soldering gun or torch, flux, soft or silver solder and a small amount of epoxy resin or potting material. A small staking tool may be used if desired to stake the ferrule and sleeve together.

Open end of sheathed thermocouples should be sealed with a moisture sealant such as "Thermoseal", after conductors have been bared prior to attaching leadwire.

Example: 1090 -

1090 -

CODE	SHEATH DIAMETER	OD OF ADAPTER
B	.040"	.250"
C	.062"	.250"
D	.125"	.250"
E	.187"	.375"
F	.250"	.375"



STAINLESS STEEL MOUNTING ADAPTER

SF316 Series

A leakproof double ferrule type compression fitting machined from 316 stainless steel. The ferrules are deformed during assembly and cannot be relocated on the thermocouple assembly. It is ideal where the probe must be removed and replaced at the same immersion depth. An excellent fitting for chemical applications or other areas that require Type 316 stainless steel for compatibility purposes. Also available with teflon ferrules - consult factory.

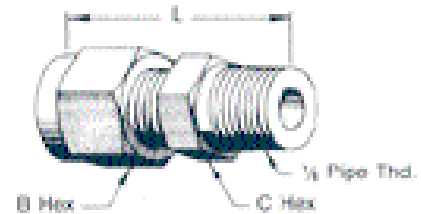

Enter a selection for each item,
please fax your inquiry to TCP.

Example: SF316 - X

X

CODE		Tube O.D.	Bore I.D.	B	C	L
Tube Size	Thread Size					
1/16"	1/8	1/16"	.065"	5/16"	7/16"	1"
1/8"	1/8	1/8"	.130"	7/16"	7/16"	1-3/16"
3/16"	1/8	3/16"	.192"	1/2"	7/16"	1-1/4"
1/4"	1/8	1/4"	.256"	9/16"	7/16"	1-5/16"

For additional combinations, consult factory.

BRASS MOUNTING ADAPTER

BF Series

A brass compression type fitting containing a ferrule to accommodate your desired probe diameter. An economical and practical fitting used in areas where pressure and temperature are relatively low. Other tube and thread combinations available. Consult factory.

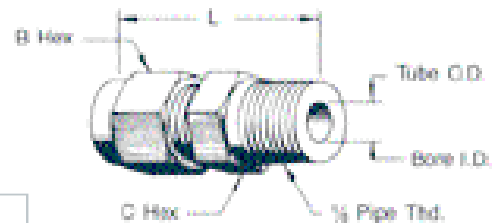

Enter a selection for each item,
please fax your inquiry to TCP.

Example: BF - X

X

CODE		Tube O.D.	Bore I.D.	B	C	L
Tube Size	Thread Size					
1/16"	1/8	1/16"	.065	5/16"	7/16"	1"
1/8"	1/8	1/8"	.130	3/8"	7/16"	31/32"
3/16"	1/8	3/16"	.192	7/16"	7/16"	1"
1/4"	1/8	1/4"	.256	1/2"	7/16"	1-3/32"

For additional combinations, consult factory.

STAINLESS STEEL MOUNTING ADAPTER WITH SEALANT

ST304 Series

- Soft sealant-type machined from stainless steel
- Sealants are available in lava, neoprene and teflon
- Replacement sealants are also available.

A soft sealant-type fitting machined from stainless steel. Thermocouple may be relocated to various immersion depths by loosening threaded cap and gland followers. Sealants are available in lava, neoprene and teflon (tetrafluoroethylene).

- The lava sealant, recommended for use up to 1850°F (1010°C), is rated up to 10,000 PSI, depending on temperature and sheath diameter.
- Teflon is recommended for applications from -90°F to 500°F.
- Neoprene Sealant is recommended for applications from -40°F to 200°F

Replacement sealant are also available.
 See page 120, 1417 series

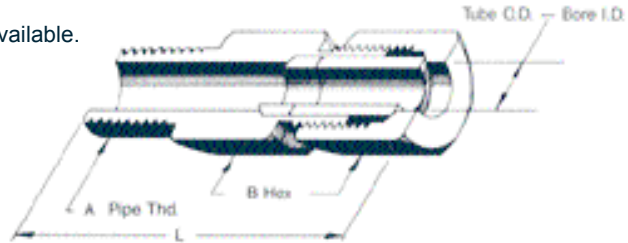

Enter a selection for each item, please fax your inquiry to TCP.

Example: ST304 - X -
 X -

CODE		Tube O.D.	Bore I.D.	B	C	L	CODE	MATERIAL
Tube Size	Thread Size							
1/16"	1/8"	1/16"	.065"	5/16"	7/16"	1"	L N T	Lava Neoprene Teflon
1/8"	1/8"	1/8"	.130"	7/16"	7/16"	1-3/16"		
3/16"	1/8"	3/16"	.192"	1/2"	7/16"	1-1/4"		
1/4"	1/4"	1/4"	.256"	9/16"	7/16"	1-5/16"		

For additional combinations, consult factory.

STAINLESS STEEL MOUNTING ADAPTER

SF304 Series

- Metal ferrule-type machined from stainless steel
- Ferrule and thermocouple sheath are deformed during installation.

A metal ferrule-type fitting machined from stainless steel. Ferrule and thermocouple sheath are deformed during installation; therefore thermocouple cannot be repositioned after metal deformation. Mounting adapter is rated to 10,000 PSI, depending on temperature and thermocouple sheath diameter.

Mounting adapter is used to mount a thermocouple at a given depth or a thermocouple head to thermocouple assembly.

Enter a selection for each item, please fax your inquiry to TCP.

Example: SF304 - X
 X



CODE		Tube O.D.	Bore I.D.
Tube Size	Thread Size		
1/16"	1/8"	1/16"	.065"
1/8"	1/8"	1/8"	.130"
3/16"	1/8"	3/16"	.192"
1/4"	1/8"	1/4"	.256"

For additional combinations, consult factory.



REPLACEMENT SEALANTS

1417 Series

Listed are replacement sealants for our ST304 Series Mounting Adapters.

When ordering, specify part number for the sealant required and add sealant material suffix letter to the end of the part number.



CODE	SHEATH DIAMETER
C	.063"
D	.125"
E	.188"
F	.250"

CODE	SHEATH MATERIAL
L	Lava
N	Neoprene
T	Teflon

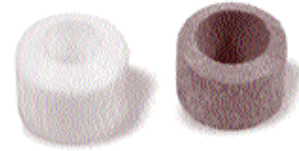

MINIATURE SCREW COVER HEAD

1020 Series

A light weight (only 3 oz.), all-aluminum head for single or duplex thermocouple elements. Readily adapted to small diameter protection wells or mineral oxide insulated sheathed thermocouples up to .250 diameter by use of a 1/8" NPT compression fitting. Also available with a 1/4" and 3/8" NPT female thread for large sheath and well diameters. Head can be subjected to a maximum operating temperature of 250°F (121°C).

Series 1020D is the standard dust cover head containing neoprene grommet around conductor outlet to prevent mechanical abrasion of the insulation. A neoprene O-ring seals the threaded cover on all models.

Series 1020W is the waterproof version of the screw cover head having a neoprene grommet at the outlet and capable of sealing leadwires from 24 gauge to 16 gauge. This cover will moisture proof the terminal head under the most adverse conditions.



CODE	COVER TYPE
1020D	Dust-Cover Head
1020W	Waterproof Head
Code 1020D is standard	

CODE	NUMBER OF TERMINALS
2	Single Terminal
4	Duplex Terminal

CODE	PIPE THREAD
1/8	1/8" NPT
1/4	1/4" NPT
3/8	3/8" NPT



BAYONET HARDWARE

The bayonet hardware illustrated provides a method of assuring positive contact between tip sensitive hot junction and the surface to be measured. The parts are designed for application with .187" diameter thermocouples but may be adapted to other sizes. All items are manufactured from stainless steel for maximum resistance to corrosion and oxidation.

These are industry standard hardware and are interchangeable with most spring loaded components on the market.

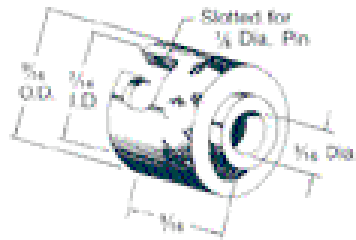

1053 Cap

Mates with the 1513 adapter with simple push and twist-action, retained by spring tension.



1082 Spring

Spring will always compress to approximately one half its relaxed length, hence it may be cut to desired size.

Typical Application

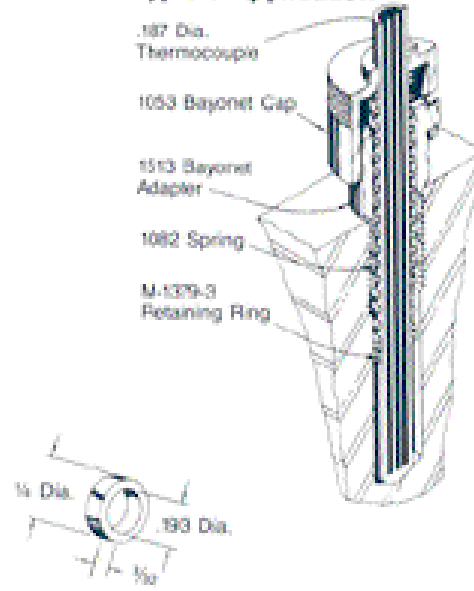

M-1379-3 Retaining Ring

Shoulder designed to transmit spring pressure to the thermocouples. Must be silver soldered to sheath.

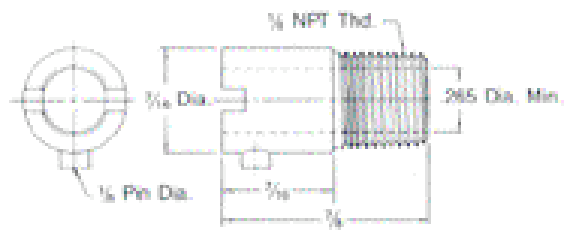

1513 Adapter

Slotted design allows fast screw-driver installation in 1/8" NPT tapped hole.



Thermo-Couple Products Co.

www.tcproducts.com

a division of Marsh Bellofram
www.marshbellofram.com
1-800-727-5646

CERAMIC TERMINAL HEAD

1015 Series For Single or Duplex Thermocouple Applications

A high-temperature binding screw type terminal similar to the 1016 Series, but capable of withstanding temperatures up to 1000°F. The four separate binding screws permit usage in duplex applications. Single thermocouples may be wired by connecting both the thermocouple and extension wire to the same binding post or linking across each pair of binding screws thus providing separate thermocouple and extension wire binding post. The stainless steel base allows attachment to sheathed thermocouples with standard silver soldering methods

Enter a selection for each item, please fax your inquiry to TCP.

Example: 1015 -

1015 -

CODE	SHEATH DIAMETER
D	.125"
E	.187"
F	.250"

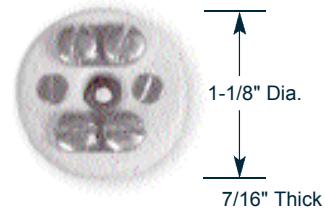

FIBERGLASS TERMINAL HEAD

1016 Series For Single Thermocouple Applications

This economical binding screw-type terminal is readily installed on Thermo-pak materials with standard silver solder. Four binding screws are provided, two for connection of thermocouple conductors and two for lead connections. This terminal has an upper temperature limit of 350°F.

Enter a selection for each item, please fax your inquiry to TCP.

Example: 1016 -

1016 -

CODE	SHEATH DIAMETER
D	.125"
E	.187"
F	.250"

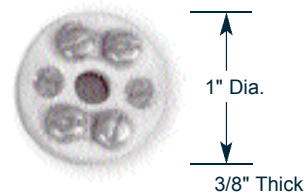

REPLACEMENT BLOCKS



1018A
Single Terminal Block
(2 Terminals)
Order 1018A



1018B
Duplex Terminal Block
(4 Terminals)
Order 1018B



1018C
Triplex Terminal Block
(6 Terminals)
Order 1018C

CAST EXPLOSION PROOF SCREW COVER HEAD

Series 1018

- Available in cast iron and aluminum
- Cover contains internal threads and gasket to assure water-tight connection
- Ceramic terminal blocks for high temperature application
- Negative lead identification by color code is indicated inside cover
- A stainless steel chain is furnished with each head for safety and easy maintenance
- Cover has minimum of eight thread engagement, in compliance with requirements for explosion-proof service

A general purpose, heavy-duty, gasket sealed screw cover head available with a single or duplex terminal block. Recommended for installations that require protection from weather or corrosive atmospheres. Factory Mutual approved for hazardous locations, explosion-proof for NEC Class 1, Division 1, Groups A, B, C and D, dust ignition proof for Class II, Division 1, Groups E, F and G; and NEMA 4 weatherproof (indoor-outdoor) and CSA Hazardous locations.

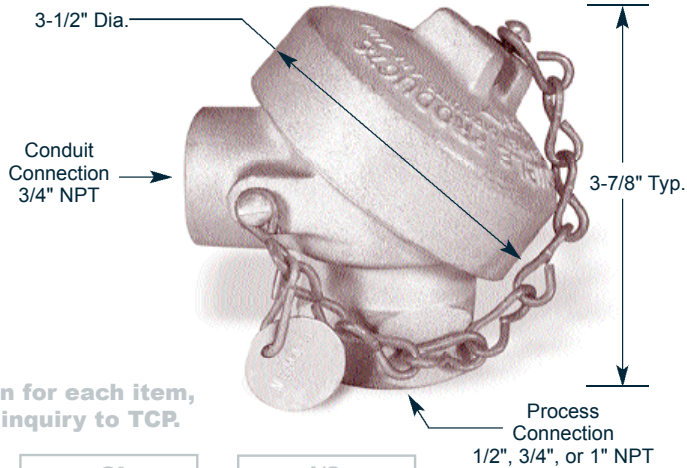

Enter a selection for each item, please fax your inquiry to TCP.

Example: 1018 - - -

1018 - - -

CODE	Terminal Styles
0	No Terminal Block
2	Single Terminal Block
4	Duplex Terminal Block
6	Triplex Terminal Block

CODE	MATERIALS
CI	Cast Iron
AL	Aluminum

CODE	PROCESS CONNECTION
1/2	1/2" NPT
3/4	3/4" NPT
1	1" NPT

POLY HEAD

1028 series

A polypropylene, gasket, screw cover head which is extremely resistant to most corrosive and capable of withstanding 220°F (105°C) continuous operations. This U-V stabilized plastic terminal head is both practical and economical. Available with either single or duplex terminal blocks to suit your needs. Utilizes the same ceramic terminal block as our 1018 series explosion-proof screw cover head. Standard connections are 1/2" NPT process with 3/4" NPT conduit.

Enter a selection for each item, please fax your inquiry to TCP.

Example: 1028 -

1028 -

CODE	TERMINAL STYLE
2	Single Terminal Block
4	Duplex Terminal Block

