

Resistance Temperature Detectors

Resistance Temperature Detectors have achieved a well deserved reputation in the industry for their superior stability and accuracy. The result makes these devices well suited for a wide variety of applications.

A Resistance Temperature Detector (RTD) senses heat based on the principle that a change in temperature results in a corresponding change in the resistance of a wire. The hotter the wires become, the larger or higher the value of their electrical resistance. RTDs are among the most precise temperature sensors available.

The RTD can be comprised of many different termination styles as seen on the following pages. The RTD element is manufactured by winding a wire or plating a film on a ceramic or glass core. Usually RTDs are provided encapsulated in probes for temperature sensing and measurement with an external indicator, controller or transmitter, or enclosed inside other devices where they measure temperature as a part of the device's function, such as a temperature controller or precision thermostat.

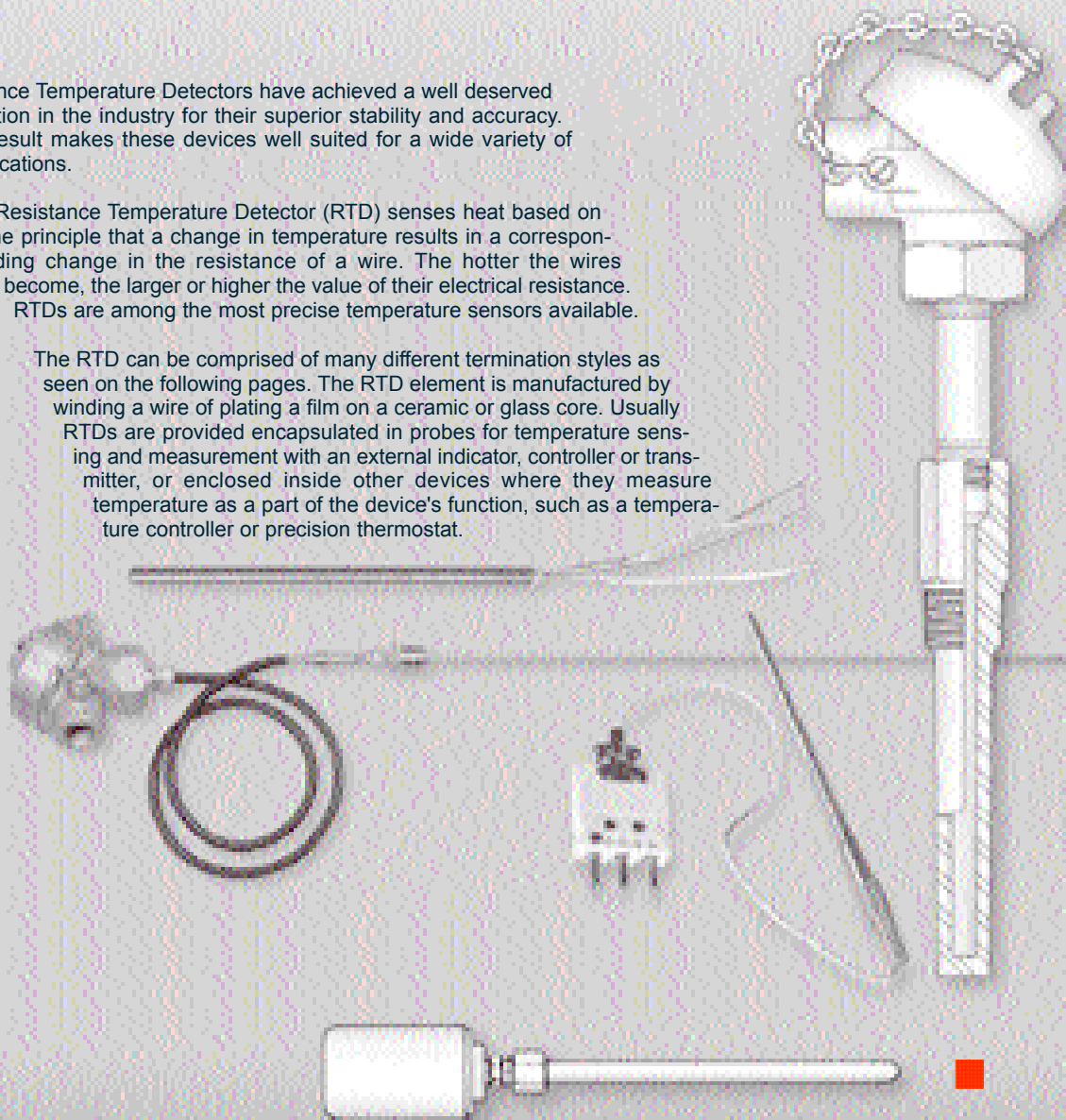

RTDs

RTD Selection

Just as thermocouple selection is based on the intended application, RTDs are selected in the same manner. The response time and operating environment such as temperature and atmosphere are factors as well as the length of service.

RTDs are available in a variety of combinations, the most commonly used material is platinum. TCP's standard platinum element has a resistance of 100 ohms @ 0°C and a temperature coefficient (Alpha) of 0.00385 ohm/ohm/degree C.

Platinum elements are predominantly used in the industry because they offer accuracy in a wide range.

Additionally, platinum is the most repeatable and stable of all metals. Other element materials used are copper, nickel, and nickel-iron.

TCP provides a highly sensitive line of RTDs. Standard units are supplied with a resistance of 100 ohms at 0°C. They are also available with resistances of 200, 400, 500 and 1000 ohms upon request. In addition, duplex and triplex sensors are available in a .25 inch diameter sheath.

TCP's standard RTDs have a resistance tolerance of ±0.1% at 0°C. Tolerances of ±0.3% at 0°C are available on special order. Standard 100 ohm RTDs are furnished with -45°C to 600°C (-50°F to 1200°F) temperature ranges. The maximum on the 200, 400, 500 and 1000 ohm units is 500°C (923°F).

RTDs feature a high purity platinum with a standard temperature co-efficient of 0.00385 ohm/ohm/degree C. Platinum resistance sensors with other temperature coefficients such as 0.00391 ohm/ohm/degree C or higher are available on special request.

TCP utilizes stainless-steel tube construction in all standard RTD sensors. In addition, when flexibility, fast response and dependability are required, we provide a metal sheath with a hard-packed mineral oxide insulation. This is particularly suitable for high temperature, vibration, or high pressure applications.

The advantages of using RTDs are numerous. They offer high accuracy, repeatability, and stability. Another advantage is that cold junction compensation is unnecessary. Here is a brief summary of some of the advantages and disadvantages of both thermocouples and RTDs.

Comparison of RTD's and Thermocouples

	Thermocouple	RTDs
Accuracy	Limits of error wider than RTD	Limits of error much closer than thermocouples
Ruggedness	Excellent, will not affect life expectancy of the probe	Somewhat sensitive to strain, vibration, shock and pressure
Temperature	-328° to 4200°F -200° to 2315°C	-50° to 1500°F -45° to 593°C
Size	Can be as small as .010" sheath diameter	Size limited to .062" sheath diameter
Drift	Should be calibrated periodically, higher than RTD's	0.01°C to 0.1°C per year, less drift than thermocouples
Resolution	Must resolve millivolts per degree, lower signal to noise ratio.	Ohms per degree, much higher signal to noise ratio than thermocouple
Cold Junction Reference	Required	Not Required
Lead Wire	Must match lead wire calibration to thermocouple calibration.	Can use copper lead wire for extension wire
Response	Can be made small enough for millisecond response time.	Slower. Thermal mass results in a response time of seconds or more
Sensitivity	Can be made tip sensitive	Can not readily be made tip sensitive. Thermal mass prevents tip sensitive construction.
Linearity	Non-Linear	Linear over a wide operating range
Cost	Relatively lower	Higher than thermocouples

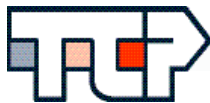

INTRODUCTION TO RTD'S

Element Construction

RTD sensor assemblies are available with 2, 3 and 4 wire leads. Two wire connected elements do not provide lead resistance compensation for the measuring device. Three and four wire connected elements provide a means for compensating lead resistance between the sensor and the measuring device.

2 Wire Single



2 Wire Duplex

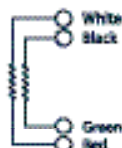

3 Wire Single

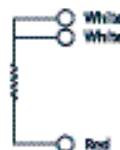

3 Wire Duplex



Three Wire: Provides one connection to one end of the element and two of the other end of the element. Connected to an instrument designed to accept three wire input, sufficient compensation is usually achieved for leadwire resistance and temperature change in leadwire resistance. This is the most commonly used configuration.

2 Wire: Provides one connection to each end of the element. This construction is suitable where the resistance of the lead wire may be considered as an additive constant in the circuit, and particularly where the changes in lead resistance due to ambient temperature changes may be ignored.

4 Wire Single

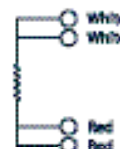

4 Wire Duplex

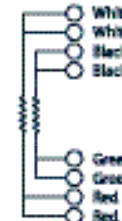

Four Wire: Provides two connections to each end of the element to completely compensate for leadwire resistance and temperature change in leadwire resistance. This configuration is used where highly accurate temperature measurement is vital.

RTD Standards

There are several RTD standards set by various organizations throughout the world. These specifications are not identical and readout instrumentation must be adjusted for the specific standard of the RTD used with that equipment. Differences in the alpha values of these standards can cause errors in measurement of an RTD if one standard is connected to the instrumentation of another standard.

Organization	Standard	Alpha (Coefficient)	Nominal Resistance (ohms) at 0°C
British Standards Association	B.S. EN 60751: 1996	0.003850	100
Fachnormenausschu B Elektrochnek im Deutschen Normenausschu B	DIN 43760	0.003850	100
International Electrotechnical Commission (Supersedes BS & DIN)	IEC 751: 1983	0.003850	100
American Society for Testing Materials	ASTM 1137	0.003920	100
US Department of Defense	MIL-T-24388	0.003920	100
Japanese Industrial Standard (JIS)	JIS C 1604-1981	0.003916	100

RESISTANCE TEMPERATURE DETECTORS

Series 303

- Superior Stability, Repeatability and Accuracy
- Vibration and Shock Resistant
- Industry Standard 3-Pin Quick Disconnect
- Standard Resistance Value 100 Ohms at 0°C, Others Available
- Standard Resistance Tolerance of ±0.1% at 0°C
- Standard Temperature Coefficient .00385 Ω/Ω/°C
- Commonly Installed with Compression Fittings (Adapter) See Pages 118 to 119.

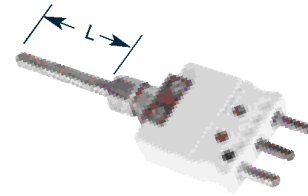

Enter a selection for each item, please fax your inquiry to TCP.

Example: 303 - A - 100 - F - 5 - 3 - 304 - 0

303 - - - - - - -

CODE	Temperature Range	Insulation
A	-50°F to 350°F (-45°C to 175°C)	FEP Teflon
B	-50°F to 800°F (-45°C to 425°C)	Fiberglass
C	-50°F to 1100°F (-45°C to 600°C)	Ceramic
D	-50°F to 1100°F (-45°C to 600°C)	Compacted MgO

RESISTANCE VALUES	
Standard: 100 Ohms at 0°C	
On request: 200, 400, 500 and 1000 Ohms	

CODE	SHEATH DIAMETER
D	.125" (A and B Temp. Range only)
E	.187"
F	.250"

IMMERSION LENGTH "L"
Specify in inches 01 to 99. For lengths over 99 inches consult factory.

CODE	OTHER PERTINENT DATA
0	NONE
Specify temperature coefficients and tolerance if other than standard. Specify duplex, or triplex RTD bushing etc, as required.	

CODE	SHEATH MATERIAL
304	304 Stainless Steel
316	316 Stainless Steel
304 Stainless Steel standard temperature Range A, B, C	
316 Stainless Steel standard Temperature Range D.	

CODE	NUMBER OF WIRES
2	2 Wire
3	3 Wire
Code 3 wire is standard	

RTDs

Metric Orders Welcome

Place an **mm** in the appropriate selection box:

100 mm

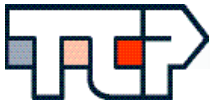

RESISTANCE TEMPERATURE DETECTORS

Series 404

- Superior Stability, Repeatability and Accuracy
- Vibration and Shock Resistant
- Industry Standard 3-Pin Quick Disconnect with Teflon flexible Lead Wire
- Standard Resistance Value 100 Ohms at 0°C, Others Available
- Standard Resistance Tolerance of $\pm 0.1\%$ at 0°C
- Standard Temperature Coefficient $.00385 \Omega/\Omega^\circ\text{C}$
- Commonly Installed with Compression Fittings (Adapter) See Pages 118 to 119.

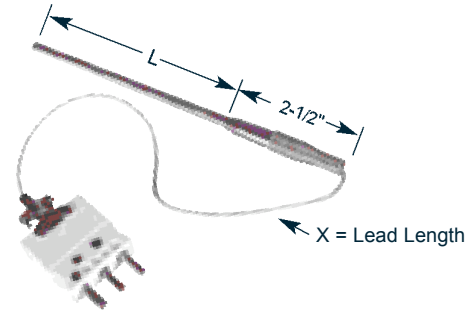

Enter a selection for each item, please fax your inquiry to TCR.

Example: 404 - A - 100 - F - 6 - 12 - 3 - 304 - 20 - 10 - 0

404 - [] - [] - [] - [] - [] - [] - [] - [] - [] - []

CODE	Temperature Range	Insulation
A	-50°F to 350°F (-45°C to 175°C)	FEP Teflon
B	-50°F to 800°F (-45°C to 425°C)	Fiberglass
C	-50°F to 1100°F (-45°C to 600°C)	Ceramic
D	-50°F to 1100°F (-45°C to 600°C)	Compacted MgO

RESISTANCE VALUES	
Standard: 100 Ohms at 0°C	
On request: 200, 400, 500 and 1000 Ohms	

CODE	SHEATH DIAMETER
D	.125" (A and B Temp. Range only)
E	.187"
F	.250"

IMMERSION LENGTH "L"
Specify in inches

LEAD LENGTH "X"
Specify in inches

CODE	NUMBER OF WIRES
2	2 Wire
3	3 Wire
4	4 Wire
Code 3 wire is standard	

CODE	OTHER PERTINENT DATA
0	NONE
Specify temperature coefficients and tolerance if other than standard. Specify duplex, or triplex RTD bushing etc, as required.	

CODE	TERMINATION STYLE
10	111 2-pin for 2 wire
40	3" Pig Tail (Bare Wire End)
70	151 3-pin plug for 3 wire
Code 10 and 70 are standard for 3 and 2 wire. Not available for 4 wire.	

CODE	LEAD WIRE
10	Fiberglass (standard)
1S	Fiberglass w/SS Overbraid
1F	Fiberglass w/SS Flexhose
20	Teflon
2S	Teflon with SS Overbraid
2F	Teflon with SS Flexhose

CODE	SHEATH MATERIAL
304	304 Stainless Steel
316	316 Stainless Steel
304 Stainless Steel standard temperature Range A, B, C	
316 Stainless Steel standard Temperature Range D.	
Specify other material	

RESISTANCE TEMPERATURE DETECTORS

Series 707

- Industrial Design with Cast Screw Cover Heads
- "Factory Mutual" Approved Heads in Cast Iron and Aluminum
- Various Male NPT Mounting Fittings are Available
- Standard Resistance Value 100 Ohms at 0°C, Others Available
- Standard Resistance Tolerance of $\pm 0.1\%$ at 0°C
- Standard Temperature Coefficient $.00385 \Omega/\Omega/^\circ\text{C}$

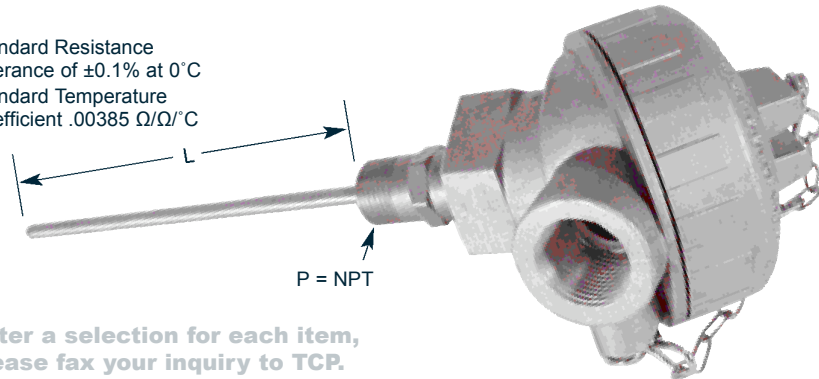

Enter a selection for each item, please fax your inquiry to TCP.

Example: 707 - A - 100 - E - 5 - 3 - 304 - AL - 1/2 - 1 - 0

707 - [] - [] - [] - [] - [] - [] - [] - [] - [] - []

CODE	Temperature Range	Insulation
A	-50°F to 350°F (-45°C to 175°C)	FEP Teflon
B	-50°F to 800°F (-45°C to 425°C)	Fiberglass
C	-50°F to 1100°F (-45°C to 600°C)	Ceramic
D	-50°F to 1100°F (-45°C to 600°C)	Compacted MgO

RESISTANCE VALUES

Standard: 100 Ohms at 0°C

On request: 200, 400, 500 and 1000 Ohms

CODE	SHEATH DIAMETER
D	.125" (A and B Temp. Range only)
E	.187"
F	.250"

IMMERSION LENGTH "L"

Specify in inches

CODE	NUMBER OF WIRES
2	2 Wire
3	3 Wire
4	4 Wire

Code 3 wire is standard

CODE	OTHER PERTINENT DATA
0	None
999	Special Request Consult Factory

CODE	SPRING LOADING
0	None
1	Spring Loaded Element

None is standard.
Spring loading not available in mounting thread is 0.

CODE	MOUNTING THREAD "P"
0	None
1/4	1/4" NPT
3/8	3/8" NPT
1/2	1/2" NPT

Code 1/2 - 1/2" NPT is standard

CODE	TERMINATION STYLE
0	None
AL	Aluminum Head
CI	Cast Iron Head
P	Poly Head

Code CI - Cast Iron is standard

CODE	SHEATH MATERIAL
304	304 Stainless Steel
316	316 Stainless Steel

304 Stainless Steel standard temperature Range A, B, C

316 Stainless Steel standard Temperature Range D.

Specify other material

! Metric Orders Welcome

Place an **mm** in the appropriate selection box:

100 mm

RTDs

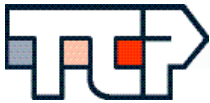

RESISTANCE TEMPERATURE DETECTORS

Series 808

- Bare Leads Provided for Termination of Your Choice
- Replacement RTD Element
- Close Interchangeability
- Standard Resistance Value 100 Ohms at 0°C, Others Available
- Standard Resistance Tolerance of $\pm 0.1\%$ at 0°C is Standard
- Standard Temperature Coefficient .00385 $\Omega/\Omega/^{\circ}\text{C}$

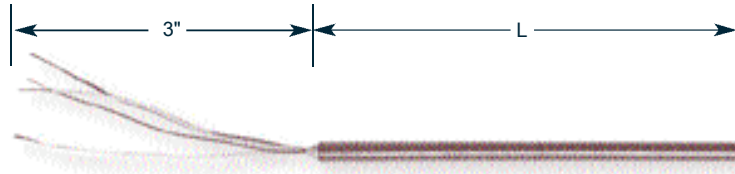

Enter a selection for each item, please fax your inquiry to TCP.

Example: 808 - - - - - - - -

808 - - - - - - - -

CODE	Temperature Range	Insulation
A	-50°F to 350°F (-45°C to 175°C)	FEP Teflon
B	-50°F to 800°F (-45°C to 425°C)	Fiberglass
C	-50°F to 1100°F (-45°C to 600°C)	Ceramic
D	-50°F to 1100°F (-45°C to 600°C)	Compacted MgO

RESISTANCE VALUES	
Standard: 100 Ohms at 0°C	
On request: 200, 400, 500 and 1000 Ohms	

CODE	SHEATH DIAMETER
D	.125" (A and B Temp. Range only)
E	.187"
F	.250"

CODE	OTHER PERTINENT DATA
0	NONE
Specify temperature coefficients and tolerance if other than standard. Specify duplex, or triplex RTD bushing etc, as required.	

CODE	SHEATH MATERIAL
304	304 Stainless Steel
316	316 Stainless Steel
304 Stainless Steel standard temperature Range A, B, C	
316 Stainless Steel standard Temperature Range D.	
Specify other material	

CODE	NUMBER OF WIRES
2	2 Wire
3	3 Wire
4	4 Wire
Code 3 wire is standard	

LEAD LENGTH "X"
Specify lead length in inches
Specify 0 if no lead required, 3" Pig tail is standard on all lead length.

IMMERSION LENGTH "L"
Specify in inches

Metric Orders Welcome

Place an **mm** in the appropriate selection box:

RESISTANCE TEMPERATURE DETECTORS

Series 909

- Superior Stability, Repeatability and Accuracy
- Vibration and Shock Resistant
- Supplied with a Lightweight Miniature Screw Coverhead
- Standard Resistance Value 100 Ohms at 0°C, Others Available
- Standard Resistance Tolerance of ± 0.1% at 0°C is Standard
- Standard Temperature Coefficient .00385 Ω/Ω/°C

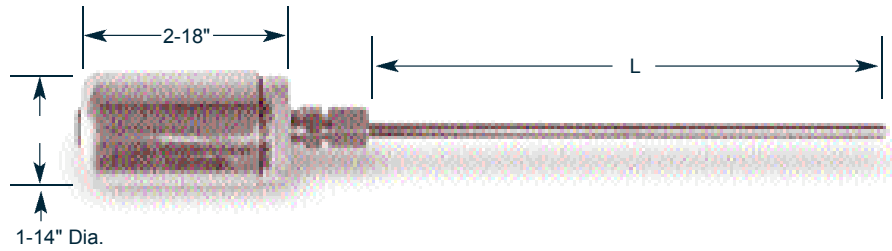

Enter a selection for each item, please fax your inquiry to TCP.

Example: 909 - A - 100 - F - 5 - 3 - 304 - 50 - 0

909 - - - - - - - - -

CODE	Temperature Range	Insulation
A	-50°F to 350°F (-45°C to 175°C)	FEP Teflon
B	-50°F to 800°F (-45°C to 425°C)	Fiberglass
C	-50°F to 1100°F (-45°C to 600°C)	Ceramic
D	-50°F to 1100°F (-45°C to 600°C)	Compacted MgO

RESISTANCE VALUES	
Standard: 100 Ohms at 0°C	
On request: 200, 400, 500 and 1000 Ohms	

CODE	SHEATH DIAMETER
D	.125" (A and B Temp. Range only)
E	.187"
F	.250"

IMMERSION LENGTH "L"
Specify in inches

CODE	OTHER PERTINENT DATA
0	NONE
Specify temperature coefficients and tolerance if other than standard. Specify duplex, or triplex RTD bushing etc, as required.	

CODE	TERMINATION STYLE
50	Dust Cover
51	Waterproof Cover
Dust Cover is standard	

CODE	SHEATH MATERIAL
304	304 Stainless Steel
316	316 Stainless Steel
304 Stainless Steel standard temperature Range A, B, C	
316 Stainless Steel standard Temperature Range D.	
Specify other material	

CODE	NUMBER OF WIRES
2	2 Wire
3	3 Wire
4	4 Wire
Code 3 wire is standard	

RTDs

Metric Orders Welcome

Place an **mm** in the appropriate selection box:

100 mm

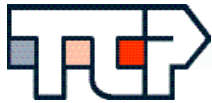

Thermo-Couple Products Co.

www.tcproducts.com

a division of Marsh Bellofram
www.marshbellofram.com
1-800-727-5646

REFINERY RTD ASSEMBLY

Series 2101

- Complete RTD Assembly with Cast Head
- PVC Coated Flex Armor Provides Moisture Resistance
- Complete with 1/2" NPT Mounting Adapter
- Design Fits Most Thermowells
- Standard Resistance Value 100 Ohms at 0°C, Others Available

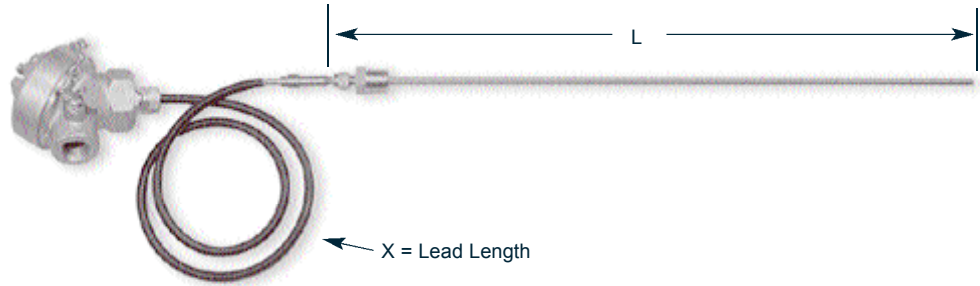

Enter a selection for each item, please fax your inquiry to TCP.

Example: 2101 - A - 100 - F - 18 - 36 - 3 - 304 - CI - 0

2101 - [] - [] - [] - [] - [] - [] - [] - [] - []

CODE	Temperature Range	Insulation
A	-50°F to 350°F (-45°C to 175°C)	FEP Teflon
B	-50°F to 800°F (-45°C to 425°C)	Fiberglass
C	-50°F to 1100°F (-45°C to 600°C)	Ceramic
D	-50°F to 1100°F (-45°C to 600°C)	Compacted MgO

RESISTANCE VALUES	
Standard: 100 Ohms at 0°C	
On request: 200, 400, 500 and 1000 Ohms	

CODE	SHEATH DIAMETER
E	.187"
F	.250"
L	.312"

Code F - .250 inches is standard
Consult factory for other diameters

Metric Orders Welcome

Place an **mm** in the appropriate selection box:

100 mm

CODE	OTHER PERTINENT DATA
0	NONE
Specify temperature coefficients and tolerance if other than standard. Specify duplex, or triplex RTD bushing etc, as required.	

CODE	TERMINATION STYLE
0	None
AL	Aluminum Head
CI	Cast Iron Head
P	Poly Head
Code CI -Cast Iron is standard	

CODE	SHEATH MATERIAL
304	304 Stainless Steel
316	316 Stainless Steel
304 Stainless Steel standard temperature Range A, B, C	
316 Stainless Steel standard Temperature Range D.	
Specify other material	

CODE	NUMBER OF WIRES
2	2 Wire
3	3 Wire
4	4 Wire
Code 3 wire is standard	

LEAD LENGTH "X"
36 inches standard, if other specify

IMMERSION LENGTH "L"
Specify in inches

RTDs

MAGNE-RTD

Series 5627

- Magnet Holding Force is 16 lbs.
- Rugged Assembly for Most Applications.
- Measures Temperature from Any Ferrous Surface
- Capable of Use to 1000°F (535°C) Without Degradation
- The Powerful Alnico Magnet Forces the Springloaded Sensing Tip Into Contact with the Sensor Surface.
- 1" Diameter

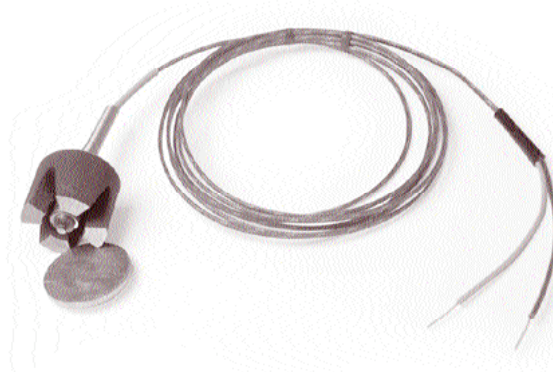

Enter a selection for each item, please fax your inquiry to TCP.

Example:

5627 A - 100 - 72 - 3 - 70 - 1S - 0

5627 - - - - - -

CODE	Temperature Range	Insulation
A	-50°F to 350°F (-45°C to 175°C)	FEP Teflon
B	-50°F to 800°F (-45°C to 425°C)	Fiberglass

RESISTANCE VALUES
Standard: 100 Ohms at 0°C
On request: 200, 400, 500 and 1000 Ohms

IMMERSION LENGTH "L"
Specify in inches 01 to 99. For lengths over 99 inches consult factory.

CODE	NUMBER OF WIRES
2	2 Wire
3	3 Wire
Code 3 wire is standard	

CODE	OTHER PERTINENT DATA
0	NONE
Specify temperature coefficients and tolerance if other than standard.	

CODE	LEAD WIRE
10	Fiberglass (standard)
1S	Fiberglass w/SS Overbraid
20	Teflon
2S	Teflon with SS Overbraid

CODE	TERMINATION STYLE
10	151 Standard Plug for 2 Wire
70	151 3-pin plug for 3 Wire
40	3" Pig Tail
Code 40 is standard	

RTDs

	Metric Orders Welcome
	Place an mm in the appropriate selection box: <input type="text" value="100 mm"/>

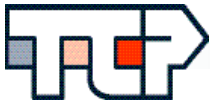

Thermo-Couple Products Co.

www.tcproducts.com

a division of Marsh Bellofram
www.marshbellofram.com
1-800-727-5646

STANDARD RTD THERMOWELL ASSEMBLY

Series 26000

- Complete RTD/Thermowell Assembly
- Supplied with an Explosion Proof Cast Head
- Resistance Value 100 Ohms at 0°C Standard, Others Available
- Resistance Tolerance of $\pm 0.1\%$ at 0°C is Standard
- Temperature Coefficient $.00385 \Omega/\Omega/^\circ\text{C}$ Standard

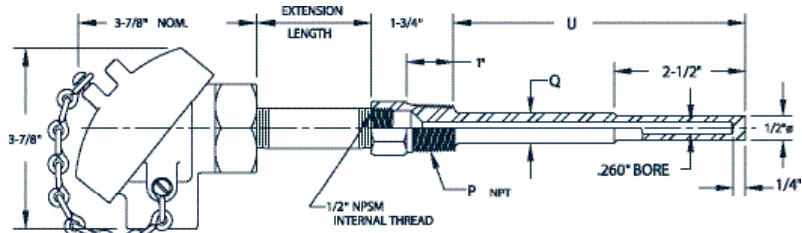

Process Connection "P"	1/2"	3/4"	1"
Diameter "Q"	5/8"	3/4"	7/8"

Example:

Enter a selection for each item, please fax your inquiry to TCP.

26000- **S** - **A** - **2** - **4** - **A** - **1S** - **3** - **3/4** - **C** - **4.5** - **0**

26000- - - - - - - - - - - -

CODE	ASSEMBLY STYLE
S	Simplex
D	Duplex
T	Triplex (Special order only)

CODE	HEAD MATERIAL
A	Aluminum
F	Cast Iron

CODE	EXTENSION CONFIGURATION
2	Head and Nipple
4	Head and Nipple/Union/Nipple

CODE	EXTENSION LENGTH
2	2"
4	4"
6	6"

CODE	Temperature Range	Insulation
A	-50°F to 350°F (-45°C to 175°C)	FEP Teflon
B	-50°F to 800°F (-45°C to 425°C)	Fiberglass
C	-50°F to 1100°F (-45°C to 600°C)	Ceramic
D	-50°F to 1100°F (-45°C to 600°C)	Compacted MgO

RESISTANCE VALUES	
1S	100 Ohm Simplex
1D	100 Ohm Duplex
1T	100 Triplex (special order)
On request: 200, 400, 500 and 1000 Ohms	

CODE	OTHER PERTINENT DATA
0	None
2	Spring Loaded
999	Special Request
Specify temperature coefficients and tolerance if other than standard.	

CODE	THERMOWELL INSERTION LENGTH "U"
2.5	2.5"
4.5	4.5"
7.5	7.5"
10.5	10.5"
13.5	13.5"
16.5	16.5"
22.5	22.5"

CODE	THERMOWELL MATERIAL
C	304 Stainless Steel
H	316 Stainless Steel
M	Monel
S	Carbon Steel (C-1018)
Other materials available on special request	

CODE	PROCESS CONNECTION "P"
1/2	1/2" NPT
3/4	3/4" NPT
1	1" NPT

CODE	NUMBER OF WIRES
2	2 Wire
3	3 Wire
4	4 Wire
Code 3 wire is standard	

RTDs

LAGGED RTD THERMOWELL ASSEMBLY

Series 26100

- Complete RTD/Lagged Thermowell Assembly
- Supplied with Threaded .260" Bore Thermowell and Explosion Proof Head
- Resistance Value 100 Ohms at 0°C Standard, Others Available
- Resistance Tolerance of ±0.1% at 0°C is Standard
- Temperature Coefficient .00385 Ω/Ω/°C Standard

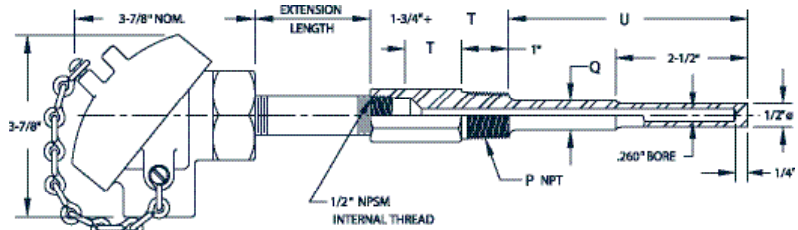

Process Connection "P"	1/2"	3/4"	1"
Diameter "Q"	5/8"	3/4"	7/8"

Example:

Enter a selection for each item, please fax your inquiry to TCP.

26100- **S** - **A** - **2** - **4** - **A** - **1S** - **3** - **3/4** - **C** - **4.5** - **0**

26100- - - - - - - - - - - -

CODE	ASSEMBLY STYLE
S	Simplex
D	Duplex
T	Triplex (Special order only)

CODE	HEAD MATERIAL
A	Aluminum
F	Cast Iron
Code F - Cast Iron is standard	

CODE	EXTENSION CONFIGURATION
2	Head and Nipple
4	Head and Nipple/Union/Nipple

CODE	EXTENSION LENGTH
2	2"
4	4"
6	6"

CODE	Temperature Range	Insulation
A	-50°F to 350°F (-45°C to 175°C)	FEP Teflon
B	-50°F to 800°F (-45°C to 425°C)	Fiberglass
C	-50°F to 1100°F (-45°C to 600°C)	Ceramic
D	-50°F to 1100°F (-45°C to 600°C)	Compacted MgO

RESISTANCE VALUES	
1S	100 Ohm Simplex
1D	100 Ohm Duplex
1T	100 Triplex (special order)
On request: 200, 400, 500 and 1000 Ohms	

CODE	OTHER PERTINENT DATA
0	None
2	Spring Loaded
999	Special Request
Specify temperature coefficients and tolerance if other than standard.	

CODE	THERMOWELL INSERTION LENGTH "U"
2.5	2.5" T = 2" Standard
4.5	4.5" T = 2" Standard
7.5	7.5" T = 3" Standard
10.5	10.5" T = 3" Standard
13.5	13.5" T = 3" Standard
16.5	16.5" T = 3" Standard
22.5	22.5" T = 3" Standard

CODE	THERMOWELL MATERIAL
C	304 Stainless Steel
H	316 Stainless Steel
M	Monel
S	Carbon Steel (C-1018)
Other materials available on special request	

CODE	PROCESS CONNECTION "P"
1/2	1/2" NPT
3/4	3/4" NPT
1	1" NPT

CODE	NUMBER OF WIRES
2	2 Wire
3	3 Wire
4	4 Wire
Code 3 wire is standard	

RTDs

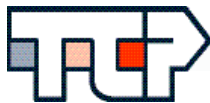

Thermo-Couple Products Co.

www.tcproducts.com

a division of Marsh Bellofram
www.marshbellofram.com
1-800-727-5646

HEAVY DUTY RTD THERMOWELL ASSEMBLY

Series 26200

- Complete RTD/Lagged Thermowell Assembly
- Supplied with Threaded .260" Bore Thermowell
- Explosion Proof-Head
- Standard Resistance Value 100 Ohms at 0°C , Others Available
- Standard Resistance Tolerance of $\pm 0.1\%$ at 0°C is Standard
- Standard Temperature Coefficient .00385 $\Omega/\text{Q}/\text{C}$ Standard

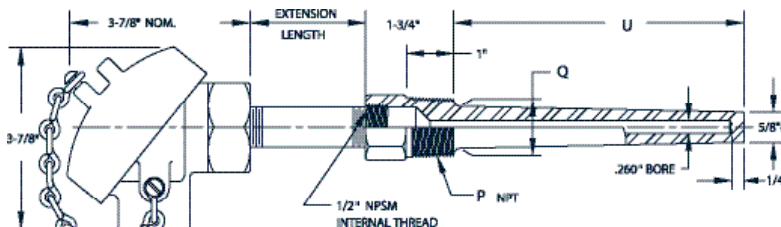

Process Connection "P"	1/2"	3/4"	1"
Diameter "Q"	5/8"	7/8"	1-1/16"

Example:

Enter a selection for each item, please fax your inquiry to TCP.

26200- **S** - **A** - **2** - **4** - **A** - **1S** - **3** - **3/4** - **C** - **4.5** - **0**

26200- - - - - - - - - - - -

CODE	ASSEMBLY STYLE
S	Simplex
D	Duplex
T	Triplex (<i>Special order only</i>)

CODE	HEAD MATERIAL
A	Aluminum
F	Cast Iron
Code F - Cast Iron is standard	

CODE	EXTENSION CONFIGURATION
2	Head and Nipple
4	Head and Nipple/Union/Nipple

CODE	EXTENSION LENGTH
2	2"
4	4"
6	6"

CODE	Temperature Range	Insulation
A	-50°F to 350°F (-45°C to 175°C)	FEP Teflon
B	-50°F to 800°F (-45°C to 425°C)	Fiberglass
C	-50°F to 1100°F (-45°C to 600°C)	Ceramic
D	-50°F to 1100°F (-45°C to 600°C)	Compacted MgO

RESISTANCE VALUES	
1S	100 Ohm Simplex
1D	100 Ohm Duplex
1T	100 Triplex (<i>special order</i>)
On request: 200, 400, 500 and 1000 Ohms	

CODE	OTHER PERTINENT DATA
0	None
2	Spring Loaded
999	Special Request
Specify temperature coefficients and tolerance if other than standard.	

CODE	THERMOWELL INSERTION LENGTH "U"
2.5	2.5"
4.5	4.5"
7.5	7.5"
10.5	10.5"
13.5	13.5"
16.5	16.5"
22.5	22.5"

CODE	THERMOWELL MATERIAL
C	304 Stainless Steel
H	316 Stainless Steel
M	Monel
S	Carbon Steel (<i>C-1018</i>)
Other materials available on special request	

CODE	PROCESS CONNECTION "P"
1/2	1/2" NPT
3/4	3/4" NPT
1	1" NPT

CODE	NUMBER OF WIRES
2	2 Wire
3	3 Wire
4	4 Wire
Code 3 wire is standard	

RTDs

HEAVY DUTY RTD LAGGED THERMOWELL ASSEMBLY

Series 26250

- Complete RTD/Lagged Thermowell Assembly
- Supplied with Threaded .260" Bore Thermowell and Explosion Proof Head
- Standard Resistance Value 100 Ohms at 0°C, Others Available
- Standard Resistance Tolerance of ±0.1% at 0°C
- Standard Temperature Coefficient .00385 Ω/Ω/°C

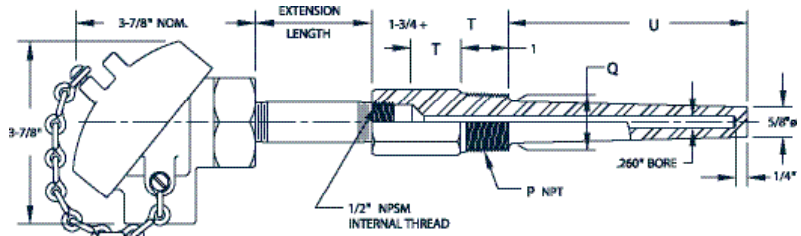

Process Connection "P"	1/2"	3/4"	1"
Diameter "Q"	5/8"	7/8"	1-1/16"

Example:

Enter a selection for each item, please fax your inquiry to TCP.

26250- **S** - **A** - **2** - **4** - **A** - **1S** - **3** - **3/4** - **C** - **4.5** - **0**

26250- - - - - - - - - - - -

CODE	ASSEMBLY STYLE
S	Simplex
D	Duplex
T	Triplex (Special order only)

CODE	HEAD MATERIAL
A	Aluminum
F	Cast Iron

Code F - Cast Iron is standard

CODE	EXTENSION CONFIGURATION
2	Head and Nipple
4	Head and Nipple/Union/Nipple

CODE	EXTENSION LENGTH
2	2"
4	4"
6	6"

CODE	Temperature Range	Insulation
A	-50°F to 350°F (-45°C to 175°C)	FEP Teflon
B	-50°F to 800°F (-45°C to 425°C)	Fiberglass
C	-50°F to 1100°F (-45°C to 600°C)	Ceramic
D	-50°F to 1100°F (-45°C to 600°C)	Compacted MgO

RESISTANCE VALUES	
1S	100 Ohm Simplex
1D	100 Ohm Duplex
1T	100 Triplex (special order)
On request: 200, 400, 500 and 1000 Ohms	

CODE	OTHER PERTINENT DATA
0	None
2	Spring Loaded
999	Special Request
Specify temperature coefficients and tolerance if other than standard.	

CODE	THERMOWELL INSERTION LENGTH "U"
2.5	2.5" T = 2" Standard
4.5	4.5"
7.5	7.5" T = 3" Standard
10.5	10.5"
13.5	13.5"
16.5	16.5"
22.5	22.5"

CODE	THERMOWELL MATERIAL
C	304 Stainless Steel
H	316 Stainless Steel
M	Monel
S	Carbon Steel (C-1018)
Other materials available on special request	

CODE	PROCESS CONNECTION "P"
1/2	1/2" NPT
3/4	3/4" NPT
1	1" NPT

CODE	NUMBER OF WIRES
2	2 Wire
3	3 Wire
4	4 Wire
Code 3 wire is standard	

RTDs

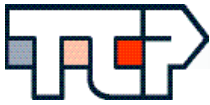

Thermo-Couple Products Co.

www.tcproducts.com

a division of Marsh Bellofram
www.marshbellofram.com
1-800-727-5646

HEAVY DUTY THERMOWELL ASSEMBLY

Series 26300

- Complete RTD/Lagged Thermowell Assembly
- Supplied with a .385" Bore Tapered Thermowell and Explosion Proof Head
- Standard Resistance Value 100 Ohms at 0°C, Others Available
- Standard Resistance Tolerance of $\pm 0.1\%$ at 0°C
- Standard Temperature Coefficient .00385 $\Omega/\Omega/^\circ\text{C}$

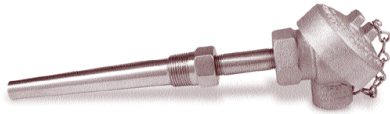
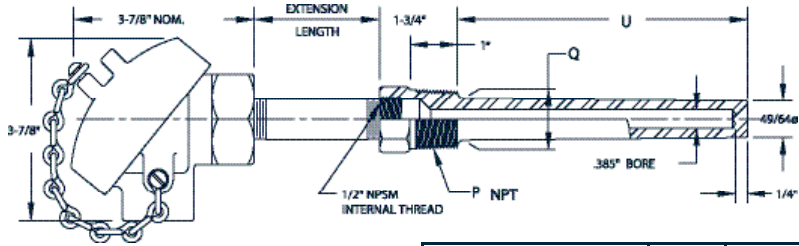

Process Connection "P"	3/4"	1"
Diameter "Q"	7/8"	1-1/16"

Example:

Enter a selection for each item, please fax your inquiry to TCP.

26300- **S** - **A** - **2** - **4** - **A** - **1S** - **3** - **1** - **C** - **4.5** - **0**

26300- - - - - - - - - - - -

RTDs

CODE	ASSEMBLY STYLE
S	Simplex
D	Duplex
T	Triplex (Special order only)

CODE	HEAD MATERIAL
A	Aluminum
F	Cast Iron
Code F - Cast Iron is standard	

CODE	EXTENSION CONFIGURATION
2	Head and Nipple
4	Head and Nipple/Union/Nipple

CODE	EXTENSION LENGTH
2	2"
4	4"
6	6"

CODE	Temperature Range	Insulation
A	-50°F to 350°F (-45°C to 175°C)	FEP Teflon
B	-50°F to 800°F (-45°C to 425°C)	Fiberglass
C	-50°F to 1100°F (-45°C to 600°C)	Ceramic
D	-50°F to 1100°F (-45°C to 600°C)	Compacted MgO

RESISTANCE VALUES	
1S	100 Ohm Simplex
1D	100 Ohm Duplex
1T	100 Triplex (special order)
On request: 200, 400, 500 and 1000 Ohms	

CODE	OTHER PERTINENT DATA
0	None
2	Spring Loaded
999	Special Request
Specify temperature coefficients and tolerance if other than standard.	

CODE	THERMOWELL INSERTION LENGTH "U"
2.5	2.5"
4.5	4.5"
7.5	7.5"
10.5	10.5"
13.5	13.5"
16.5	16.5"
22.5	22.5"

CODE	THERMOWELL MATERIAL
C	304 Stainless Steel
H	316 Stainless Steel
M	Monel
S	Carbon Steel (C-1018)
Other materials available on special request	

CODE	PROCESS CONNECTION "P"
3/4	3/4" NPT
1	1" NPT

CODE	NUMBER OF WIRES
2	2 Wire
3	3 Wire
4	4 Wire
Code 3 wire is standard	

HEAVY DUTY RTD LAGGED THERMOWELL ASSEMBLY

Series 26350

- Complete RTD/Lagged Thermowell Assembly
- Supplied with a .385" Bore Tapered Thermowell and Explosion Proof Head
- Standard Resistance Value 100 Ohms at 0°C, Others Available
- Standard Resistance Tolerance of ±0.1% at 0°C
- Standard Temperature Coefficient .00385 Ω/Ω/°C

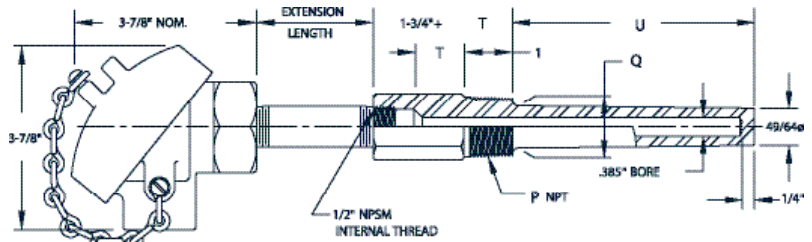

Process Connection "P"	3/4"	1"
Diameter "Q"	7/8"	1-1/16"

Example:

Enter a selection for each item, please fax your inquiry to TCP.

26350- **S** - **A** - **2** - **4** - **A** - **1S** - **3** - **1** - **C** - **4.5** - **0**

26350- - - - - - - - - - - -

CODE	ASSEMBLY STYLE
S	Simplex
D	Duplex
T	Triplex (<i>Special order only</i>)

CODE	HEAD MATERIAL
A	Aluminum
F	Cast Iron

Code F - Cast Iron is standard

CODE	EXTENSION CONFIGURATION
2	Head and Nipple
4	Head and Nipple/Union/Nipple

CODE	EXTENSION LENGTH
2	2"
4	4"
6	6"

CODE	Temperature Range	Insulation
A	-50°F to 350°F (-45°C to 175°C)	FEP Teflon
B	-50°F to 800°F (-45°C to 425°C)	Fiberglass
C	-50°F to 1100°F (-45°C to 600°C)	Ceramic
D	-50°F to 1100°F (-45°C to 600°C)	Compacted MgO

RESISTANCE VALUES	
1S	100 Ohm Simplex
1D	100 Ohm Duplex
1T	100 Triplex (<i>special order</i>)
On request: 200, 400, 500 and 1000 Ohms	

CODE	OTHER PERTINENT DATA
0	None
2	Spring Loaded
999	Special Request
Specify temperature coefficients and tolerance if other than standard.	

CODE	THERMOWELL INSERTION LENGTH "U"
2.5	2.5" T = 2" Standard
4.5	4.5" T = 2" Standard
7.5	7.5" T = 3" Standard
10.5	10.5" T = 3" Standard
13.5	13.5" T = 3" Standard
16.5	16.5" T = 3" Standard
22.5	22.5" T = 3" Standard

CODE	THERMOWELL MATERIAL
C	304 Stainless Steel
H	316 Stainless Steel
M	Monel
S	Carbon Steel (<i>C-1018</i>)
Other materials available on special request	

CODE	PROCESS CONNECTION "P"
3/4	3/4" NPT
1	1" NPT

CODE	NUMBER OF WIRES
2	2 Wire
3	3 Wire
4	4 Wire
Code 3 wire is standard	

RTDs

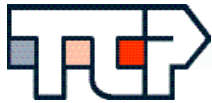

Thermo-Couple Products Co.

www.tcproducts.com

a division of Marsh Bellofram
www.marshbellofram.com
1-800-727-5646

FLANGED RTD THERMOWELL ASSEMBLY

Series 26700

- Flange Fully Welded to Thermowell
- .260" Bore Flanged Thermowell Assembly and Explosion Proof Head
- Standard Resistance Tolerance of $\pm 0.1\%$ at 0°C
- Standard Temperature Coefficient $.00385 \Omega/\Omega/^\circ\text{C}$

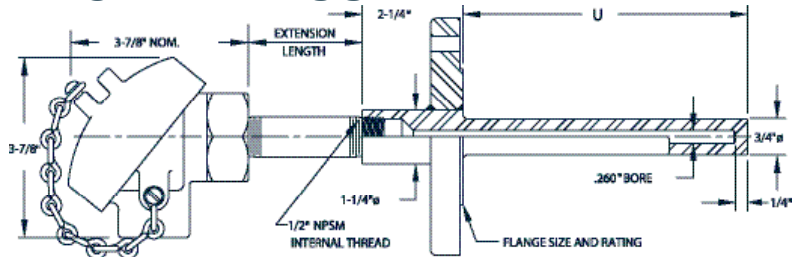
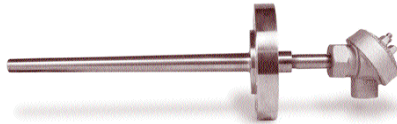

Bore "B"	.260"
Diameter "Q"	3/4"

Example:

Enter a selection for each item, please fax your inquiry to TCP.

26700- S - A - 2 - 4 - A - 1S - 3 - 1 - 150 - RF - C - 4 - 0

26700- [] - [] - [] - [] - [] - [] - [] - [] - [] - [] - [] - [] - []

CODE	ASSEMBLY STYLE
S	Simplex
D	Duplex
T	Triplex (<i>Special order only</i>)

CODE	HEAD MATERIAL
A	Aluminum
F	Cast Iron

Code F - Cast Iron is standard

CODE	EXTENSION CONFIGURATION
2	Head and Nipple
4	Head and Nipple/Union/Nipple

CODE	EXTENSION LENGTH
2	2"
4	4"
6	6"

CODE	Temperature Range	Insulation
A	-50°F to 350°F (-45°C to 175°C)	FEP Teflon
B	-50°F to 800°F (-45°C to 425°C)	Fiberglass
C	-50°F to 1100°F (-45°C to 600°C)	Ceramic
D	-50°F to 1100°F (-45°C to 600°C)	Compacted MgO

RESISTANCE VALUES	
1S	100 Ohm Simplex
1D	100 Ohm Duplex
1T	100 Triplex (<i>special order</i>)

On request: 200, 400, 500 and 1000 Ohms

CODE	NUMBER OF WIRES
2	2 Wire
3	3 Wire
4	4 Wire

Code 3 wire is standard

CODE	OTHER PERTINENT DATA
0	None
2	Spring Loaded
999	Special Request

Specify temperature coefficients and tolerance if other than standard.

CODE	THERMOWELL INSERTION LENGTH "U"
2	2"
4	4"
7	7"
10	10"
13	13"
16	16"
22	22"

Others consult factory

CODE	THERMOWELL MATERIAL
C	304 Stainless Steel
H	316 Stainless Steel
M	Monel
S	Carbon Steel (C-1018)

Other materials available on special request

CODE	FLANGE FACE
RF	Raised Face
RTJ	Ring Type Joint

CODE	FLANGE RATING
150	150 lb
300	300 lb
600	600 lb
900	900 lb
1500	1500 lb

CODE	FLANGE FACE
1	1"
1.5	1-1/2"
2	2"

RTDs

VAN STONE RTD THERMOWELL ASSEMBLY

Series 26800

- .260" Bore Van Stone Thermowell Assembly and Explosion Proof Head
- Standard Resistance Tolerance of $\pm 0.1\%$ at 0°C
- Standard Temperature Coefficient $.00385 \Omega/\Omega/^\circ\text{C}$

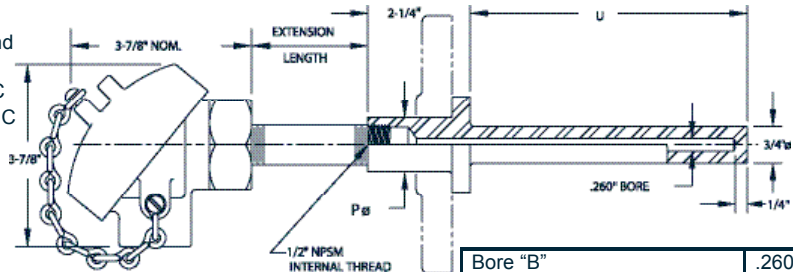
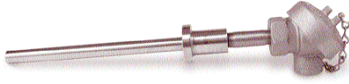

Bore "B"	.260"
Diameter "Q"	3/4"

Example:

Enter a selection for each item, please fax your inquiry to TCP.

26800- **S** - **A** - **2** - **4** - **A** - **1S** - **3** - **1** - **150** - **LJ** - **C** - **4** - **0**

26800- - - - - - - - - - - - - -

CODE	ASSEMBLY STYLE
S	Simplex
D	Duplex
T	Triplex (<i>Special order only</i>)

CODE	HEAD MATERIAL
A	Aluminum
F	Cast Iron
Code F - Cast Iron is standard	

CODE	EXTENSION CONFIGURATION
2	Head and Nipple
4	Head and Nipple/Union/Nipple

CODE	EXTENSION LENGTH
2	2"
4	4"
6	6"
Code 6 is standard size 6"	

CODE	Temperature Range	Insulation
A	-50°F to 350°F (-45°C to 175°C)	FEP Teflon
B	-50°F to 800°F (-45°C to 425°C)	Fiberglass
C	-50°F to 1100°F (-45°C to 600°C)	Ceramic
D	-50°F to 1100°F (-45°C to 600°C)	Compacted MgO

RESISTANCE VALUES	
1S	100 Ohm Simplex
1D	100 Ohm Duplex
1T	100 Triplex (<i>special order</i>)
On request: 200, 400, 500 and 1000 Ohms	

CODE	NUMBER OF WIRES
2	2 Wire
3	3 Wire
4	4 Wire
Code 3 wire is standard	

CODE	OTHER PERTINENT DATA
0	None
2	Spring Loaded
999	Special Request
Specify temperature coefficients and tolerance if other than standard.	

CODE	THERMOWELL INSERTION LENGTH "U"
2	2"
4	4"
7	7"
10	10"
13	13"
16	16"
22	22"
Others consult factory	

CODE	THERMOWELL MATERIAL
C	304 Stainless Steel
H	316 Stainless Steel
M	Monel
S	Carbon Steel (C-1018)
Other materials available on special request	

CODE	FLANGE FACE
0	None
LJ	Lap Joint
Lap Joint material is Carbon Steel	

CODE	FLANGE RATING
0	None
150	150 lb
300	300 lb

CODE	FLANGE FACE
1	1"
1.5	1-1/2"

RTDs

TEMPERATURE / RESISTANCE RELATIONSHIP AND TOLERANCE FOR ALPHA OF .00385Ω/Ω/ °C

Table of Temperature / Resistance Relationship and Tolerance for Alpha of .00385Ω/Ω/ °C

°C (°F)	0	-10	-20	-30	-40	-50	-60	-70	-80	-90	-100
-100 (-148)	60.25	56.19	52.11	48.00	43.87	39.71	35.53	31.32	27.08	22.80	18.49
0 (32)	100.00	96.09	92.16	88.22	84.27	80.31	76.33	72.33	68.33	64.30	60.25
°C (°F)	0	10	20	30	40	50	60	70	80	90	100
0 (32)	100.00	103.90	107.79	111.67	115.54	119.40	123.24	127.07	130.89	134.70	138.50
100 (212)	138.50	142.29	146.06	149.82	153.54	157.31	161.04	164.76	168.46	172.16	175.84
200 (392)	175.84	179.51	183.17	186.82	190.45	194.07	197.69	201.29	204.88	208.45	212.02
300 (572)	212.02	215.57	219.12	222.65	226.17	229.67	233.17	236.65	240.13	243.59	247.04
400 (752)	247.04	250.48	253.90	257.32	260.72	264.11	267.49	270.86	274.22	277.56	280.90
500 (932)	280.90	284.22	287.53	290.83	294.11	297.39	300.65	303.91	307.15	310.38	313.59
600 (1,112)	313.59	316.80	319.99	323.18	326.35	329.51	332.66	335.79	338.92	342.03	345.13
700 (1,292)	345.13	348.22	351.30	354.37	357.42	360.47	363.50	366.52	369.53	372.52	375.51
800 (1,472)	375.51	381.45	381.45	384.40	387.34	390.26	---	---	---	---	---

Table of Tolerance Values (Ref. DIN 43760)

Temperature	Resistance Value	Tolerance			
		Class A		Class B	
		TEMP.	OHMS	TEMP.	OHMS
-200	18.49	±0.55	±0.24	±1.3	±0.56
-100	60.25	±0.35	±0.14	±0.8	±0.32
0	100.00	±0.15	±0.06	±0.3	±0.12
100	138.50	±0.35	±0.13	±0.8	±0.30
200	175.84	±0.55	±0.20	±1.3	±0.48
300	212.02	±0.75	±0.27	±1.8	±0.64
400	247.04	±0.95	±0.33	±2.3	±0.79
500	280.90	±1.15	±0.38	±2.8	±0.93
600	313.59	±1.35	±0.43	±3.3	±1.06
650	329.51	±1.45	±0.46	±3.6	±1.13
700	345.13			±3.8	±1.17
800	375.51			±4.3	±1.28
850	390.26			±4.6	±1.34

RTDs